

PEETER JOOT PEETERJOOT@PROTONMAIL.COM

ELECTROMAGNETIC THEORY

ELECTROMAGNETIC THEORY

PEETER JOOT PEETERJOOT@PROTONMAIL.COM

Notes and problems from UofT ECE1228H 2016

February 2019 – version V0.1.13

COPYRIGHT

Copyright ©2019 Peeter Joot All Rights Reserved

This book may be reproduced and distributed in whole or in part, without fee, subject to the following conditions:

- The copyright notice above and this permission notice must be preserved complete on all complete or partial copies.
- Any translation or derived work must be approved by the author in writing before distribution.
- If you distribute this work in part, instructions for obtaining the complete version of this document must be included, and a means for obtaining a complete version provided.
- Small portions may be reproduced as illustrations for reviews or quotes in other works without this permission notice if proper citation is given.

Exceptions to these rules may be granted for academic purposes: Write to the author and ask.

Disclaimer: I confess to violating somebody's copyright when I copied this copyright statement.

DOCUMENT VERSION

Version V0.1.13

Sources for this notes compilation can be found in the github repository

[git@github.com:peeterjoot/latex-notes-compilations.git](https://github.com/peeterjoot/latex-notes-compilations.git)

The last commit (Feb/14/2019), associated with this pdf was

3c9cb6fa485ed9f1e23eb9081214c5f6a4d3fdaa

Dedicated to:
Aurora and Lance, my awesome kids, and
Sofia, who not only tolerates and encourages my studies, but is also awesome enough to think
that math is sexy.

PREFACE

This document was produced while taking the Fall 2016, University of Toronto Electromagnetic Theory course (ECE1228H), taught by Prof. M. Mojahedi.

Course Syllabus This course covers the Fundamentals of electromagnetic theory, including (time permitting) topics such as

- Maxwell's equations
- constitutive relations and boundary conditions
- wave polarization.
- Field representations: potentials
- Green's functions and integral equations.
- Theorems and concepts: duality, uniqueness, images, equivalence, reciprocity and Babinet's principles.
- Plane cylindrical and spherical waves and waveguides.
- radiation and scattering.

This course, despite being offered as a grad course, turned out to be largely an introductory course.

THIS DOCUMENT IS REDACTED. THE PROBLEM SET SOLUTIONS ARE NOT VISIBLE. PLEASE EMAIL ME FOR THE FULL VERSION IF YOU ARE NOT TAKING ECE1228.

This document contains:

- Lecture notes (or transcriptions from the class slides when they went too fast).
- Personal notes exploring auxiliary details.
- Worked practice problems.
- Links to Mathematica notebooks associated with the course material and problems (but not problem sets).

My thanks go to Professor Mojahedi for teaching this course.

Peeter Joot peeterjoot@protonmail.com

CONTENTS

Preface	xi
I LECTURE NOTES	1
1 INTRODUCTION	3
2 BOUNDARIES	7
2.1 Problems	12
3 ELECTROSTATICS AND DIPOLES.	21
3.1 Problems	28
4 MAGNETIC MOMENT, AND BOUNDARY VALUE CONDITIONS	31
4.1 Problems	37
5 POYNTING VECTOR, AND TIME HARMONIC (PHASOR) FIELDS.	43
5.1 Problems	49
5.2 Problems	57
6 DRUID MODEL	61
6.1 Problems	64
7 WAVE EQUATION	65
7.1 Problems	66
8 WAVE EQUATION SOLUTIONS	69
8.1 Problems	69
9 WAVE EQUATION SOLUTIONS	73
9.1 Problems	75
10 QUADRUPOLE EXPANSION	79
10.1 Problems	85
11 FRESNEL RELATIONS	87
11.1 Single interface TE mode.	87
11.2 Single interface TM mode.	90
11.3 Normal transmission and reflection through two interfaces.	92
11.4 Total internal reflection	95
11.5 Brewster's angle	97
11.6 Problems	99
12 GAUGE FREEDOM.	107
12.1 Problems	107

II	APPENDICES	109
A	USEFUL FORMULAS AND REVIEW	111
B	GEOMETRIC ALGEBRA	115
C	JACKSON'S ELECTROSTATIC SELF ENERGY ANALYSIS	121
D	MAGNETOSTATIC FORCE AND TORQUE.	127
E	LINE CHARGE FIELD AND POTENTIAL	131
F	GRADIENT, DIVERGENCE, CURL AND LAPLACIAN IN CYLINDRICAL COORDINATES.	137
G	GRADIENT, DIVERGENCE, CURL AND LAPLACIAN IN SPHERICAL COORDINATES.	143
H	VECTOR WAVE EQUATION IN SPHERICAL COORDINATES	151
I	TRANSVERSE GAUGE	157
J	MATHEMATICA NOTEBOOKS	161
III	INDEX	163
IV	BIBLIOGRAPHY	169
	BIBLIOGRAPHY	171

LIST OF FIGURES

Figure 2.1	Loop and pillbox configurations.	7
Figure 2.2	Grating.	9
Figure 2.3	Anisotropic field relations.	9
Figure 2.4	Field lines	13
Figure 2.5	Field lines.	14
Figure 2.6	Conducting sheet with a hole.	15
Figure 2.7	Line charge.	17
Figure 3.1	Vector distance from charge to observation point.	22
Figure 3.2	Dipole sign convention.	23
Figure 3.3	Circuit with displacement current.	25
Figure 3.4	Glass dielectric capacitor bound charge dipole configurations.	25
Figure 3.5	A p-orbital dipole like electronic configuration.	26
Figure 3.6	Electric dipole configuration.	28
Figure 3.7	Circular disk geometry.	29
Figure 4.1	Orientation of current loop.	31
Figure 4.2	External magnetic field alignment of magnetic moments.	32
Figure 4.3	Equal tangential fields.	34
Figure 4.4	Boundary geometry.	35
Figure 4.5	Boundary geometry.	39
Figure 4.6	Current loop.	40
Figure 5.1	LC circuit.	45
Figure 5.2	Inductor.	45
Figure 5.3	Capacitor.	46
Figure 5.4	Non-sinusoidal time dependence.	47
Figure 5.5	Field refraction.	49
Figure 5.6	Undamped resonance.	56
Figure 5.7	Damped resonance.	56
Figure 6.1	Metal reflectivity.	63
Figure 8.1	Superluminal tunneling.	69
Figure 8.2	Linear wave front.	70
Figure 9.1	Right handed triplet.	76
Figure 11.1	Electric field TE mode Fresnel geometry.	87
Figure 11.2	Two interface transmission.	93
Figure 11.3	Transmission angle vs incident angle.	95

Figure 11.4	TM mode geometry.	100
Figure 11.5	Slab geometry.	101
Figure 11.6	1DPC photonic crystal.	103
Figure 11.7	Finite photonic crystal.	104

Part I

LECTURE NOTES

INTRODUCTION

Conventions for Maxwell's equations In these course notes, Maxwell's equations will be written in one of two forms. The first is the standard bold face vectors, where the fields are assumed to be real.

- Faraday's Law

$$\nabla \times \mathbf{E}(\mathbf{r}, t) = -\frac{\partial \mathbf{B}}{\partial t}(\mathbf{r}, t) - \mathbf{M}_i \quad (1.1)$$

- Ampere-Maxwell equation

$$\nabla \times \mathbf{H}(\mathbf{r}, t) = \mathbf{J}_c(\mathbf{r}, t) + \frac{\partial \mathbf{D}}{\partial t}(\mathbf{r}, t) \quad (1.2)$$

- Gauss's law

$$\nabla \cdot \mathbf{D}(\mathbf{r}, t) = \rho_{ev}(\mathbf{r}, t) \quad (1.3)$$

- Gauss's law for magnetism

$$\nabla \cdot \mathbf{B}(\mathbf{r}, t) = \rho_{mv}(\mathbf{r}, t), \quad (1.4)$$

In chapters where frequency domain analysis is used, Maxwell's equations will be written in script

$$\begin{aligned} \nabla \times \mathcal{E} &= -\frac{\partial \mathcal{B}}{\partial t} - \mathcal{M} \\ \nabla \times \mathcal{H} &= \frac{\partial \mathcal{D}}{\partial t} + \mathcal{J} \\ \nabla \times \mathcal{B} &= q_{mv} \\ \nabla \times \mathcal{D} &= q_{ev} \end{aligned} \quad (1.5)$$

with bold face reserved for complex valued field variables. In the frequency domain (called time harmonic form in this class), the frequency dependence is of the form

$$\mathcal{X} = \text{Re}(\mathbf{X}e^{j\omega t}). \quad (1.6)$$

In this form, Maxwell's equations are

$$\begin{aligned}
 \nabla \times \mathbf{E} &= -j\omega\mathbf{B} - \mathbf{M} \\
 \nabla \times \mathbf{H} &= j\omega\mathbf{D} + \mathbf{J} \\
 \nabla \times \mathbf{B} &= \rho_{mv} \\
 \nabla \times \mathbf{D} &= \rho_{ev}
 \end{aligned}
 \tag{1.7}$$

Where there is no ambiguity, bold face vectors will be used, even in the time domain.

Units. Regardless of the conversions, after unpacking, we have a total of eight equations, with four vectorial field variables, and 8 sources, all interrelated by partial derivatives in space and time coordinates.

It will be left to homework to show that without the displacement current $\partial\mathbf{D}/\partial t$, these equations will not satisfy conservation relations.

The fields are and sources are

- \mathbf{E} Electric field intensity V/m.
- \mathbf{B} Magnetic flux density Vs/m² (or Tesla).
- \mathbf{H} Magnetic field intensity A/m.
- \mathbf{D} Electric flux density C/m².
- ρ_{ev} Electric charge volume density
- ρ_{mv} Magnetic charge volume density
- \mathbf{J}_c Impressed (source) electric current density A/m². This is the charge passing through a plane in a unit time. Here c is for "conduction".
- \mathbf{M}_i Impressed (source) magnetic current density V/m²

In an undergrad context we'll have seen the electric and magnetic fields in the Lorentz force law

$$\mathbf{F} = q\mathbf{v} \times \mathbf{B} + q\mathbf{E}.
 \tag{1.8}$$

In SI there are 7 basic units. These include

- Length m.
- mass kg.
- Time s.

- Ampere A.
- Kelvin K (temperature)
- Candela (luminous intensity)
- Mole (amount of substance)

Note that the Coulomb is not a fundamental unit, but the Ampere is. This is because it is easier to measure.

For homework: show that magnetic field lines must close on themselves when there are no magnetic sources (zero divergence). This is opposed to electric fields that spread out from the charge.

2

BOUNDARIES

Integral forms Given Maxwell's equations at a point

$$\begin{aligned}\nabla \times \mathbf{E} &= -\frac{\partial \mathbf{B}}{\partial t} \\ \nabla \times \mathbf{H} &= \mathbf{J} + \frac{\partial \mathbf{D}}{\partial t} \\ \nabla \cdot \mathbf{D} &= \rho_v \\ \nabla \cdot \mathbf{B} &= 0\end{aligned}\tag{2.1}$$

what happens when we have different fields and currents on two sides of a boundary? To answer these questions, we want to use the integral forms of Maxwell's equations, over the geometries illustrated in fig. 2.1.

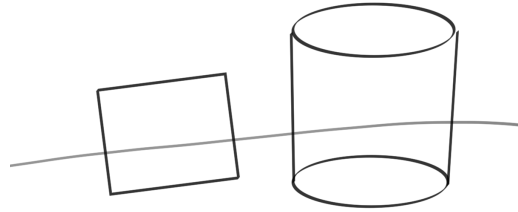

Figure 2.1: Loop and pillbox configurations.

To do so, we use Stokes' and the divergence theorems relating the area and volume integrals to the surfaces of those geometries.

These are

$$\begin{aligned}\iint_S (\nabla \times \mathbf{A}) \cdot d\mathbf{s} &= \oint_C \mathbf{A} \cdot d\mathbf{l} \\ \iint_V (\nabla \cdot \mathbf{A}) ds &= \oint_A \mathbf{A} \cdot d\mathbf{s}\end{aligned}\tag{2.2}$$

Application of the Stokes' to Faraday's law we get

$$\oint_C \mathbf{E} \cdot d\mathbf{l} = -\frac{\partial}{\partial t} \iint \mathbf{B} \cdot d\mathbf{s}\tag{2.3}$$

UNITS: $V/m \times m$

The quantity

$$\iint \mathbf{B} \cdot d\mathbf{s}, \quad (2.4)$$

is called the magnetic flux of \mathbf{B} , and changing of this flux is responsible for the generation of electromotive force.

Similarly

$$\begin{aligned} \oint \mathbf{H} \cdot d\mathbf{l} &= \iint \mathbf{J} \cdot d\mathbf{s} + \frac{\partial}{\partial t} \iint \mathbf{D} \cdot d\mathbf{s} \\ \oint \mathbf{D} \cdot d\mathbf{s} &= \iiint \rho_v dV = Q_e \\ \oint \mathbf{B} \cdot d\mathbf{s} &= 0. \end{aligned} \quad (2.5)$$

Constitutive relations With 12 unknowns in \mathbf{E} , \mathbf{B} , \mathbf{D} , \mathbf{H} and 8 equations in Maxwell's equations (or 6 if the divergence equations are considered redundant), things don't look too good for solutions. In simple media, in the frequency domain, relations of the form

$$\begin{aligned} \mathbf{D}(\mathbf{r}, \omega) &= \epsilon \mathbf{E}(\mathbf{r}, \omega) \\ \mathbf{B}(\mathbf{r}, \omega) &= \mu \mathbf{H}(\mathbf{r}, \omega). \end{aligned} \quad (2.6)$$

The permeabilities ϵ and μ are macroscopic beasts, determined either experimentally, or theoretically using an averaging process involving many (millions, or billions, or more) particles. However, the theoretical determinations that have been attempted do not work well in practise and usually end up considerably different than the measured values. We are referred to [8] for one attempt to model the statistical microscopic effects non-quantum mechanically to justify the traditional macroscopic form of Maxwell's equations.

These can be position dependent, as in the grating sketched in fig. 2.2.

The permeabilities can also depend on the strength of the fields. An example, application of an electric field to gallium arsenide or glass can change the behaviour in the material. We can also have non-linear effects, such as the effect on a capacitor when the voltage is increased. The response near the breakdown point where the capacitor blows up demonstrates this spectacularly. We can also have materials for which the permeabilities depend on the direction of the field, or the temperature, or the pressure in the environment, the tensile or compression forces on the material, or many other factors. There are many other possible complicating factors, for example, the electric response ϵ can depend on the magnetic field strength $|\mathbf{B}|$. We could then write

$$\epsilon = \epsilon(\mathbf{r}, |\mathbf{E}|, \mathbf{E}/|\mathbf{E}|, T, P, |\boldsymbol{\eta}|, \omega, k). \quad (2.7)$$

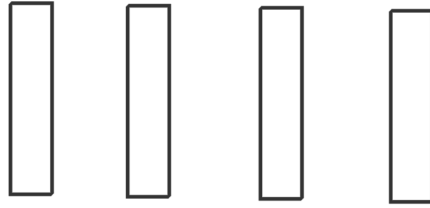

Figure 2.2: Grating.

Further complicating things is that ϵ is a complex number (for fields specified in the frequency domain).

We can also have anisotropic situations where the electric and displacement fields are no longer colinear as sketched in fig. 2.3.

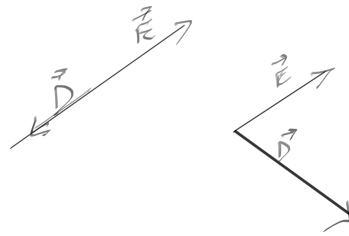

Figure 2.3: Anisotropic field relations.

which indicates that the permittivity ϵ in the relation

$$\mathbf{D} = \epsilon \mathbf{E}, \quad (2.8)$$

can be modelled as a matrix or as a second rank tensor. When the off diagonal entries are zero, and the diagonal values are all equal, we have the special case where ϵ is reduced to a function. That function may still be complex-valued, and dependent on many factors, but it least it is scalar valued in this situation.

Polarization and magnetization If we have a material (such as glass), we can generally assume that the induced field can be related to the vacuum field according to

$$\mathbf{E} = \mathbf{P} + \epsilon_0 \mathbf{E}, \quad (2.9)$$

and

$$\begin{aligned}\mathbf{B} &= \mu_0 \mathbf{M} + \mu_0 \mathbf{H} \\ &= \mu_0 (\mathbf{M} + \mathbf{H}).\end{aligned}\tag{2.10}$$

Here the vacuum permittivity ϵ_0 has the value 8.85×10^{-12} F/m. When we are ignoring (fictional) magnetic sources, we have a constant relation between the magnetic fields $\mathbf{B} = \mu_0 \mathbf{H}$.

Assuming $\mathbf{P} = \epsilon_0 \chi_e \mathbf{E}$, then

$$\begin{aligned}\mathbf{D} &= \epsilon_0 \mathbf{E} + \epsilon_0 \chi_e \mathbf{E} \\ &= \epsilon_0 (1 + \chi_e) \mathbf{E},\end{aligned}\tag{2.11}$$

so with $\epsilon_r = 1 + \chi_e$, and $\epsilon = \epsilon_0 \epsilon_r$ we have

$$\mathbf{D} = \epsilon \mathbf{E}.\tag{2.12}$$

Note that the relative permittivity ϵ_r is dimensionless, whereas the vacuum permittivity has units of F/m. We call ϵ the (unqualified) permittivity. The relative permittivity ϵ_r is sometimes called the relative permittivity.

Another useful quantity is the index of refraction

$$\begin{aligned}\eta &= \sqrt{\epsilon_r \mu_r} \\ &\approx \sqrt{\epsilon_r}.\end{aligned}\tag{2.13}$$

Similar to the above we can write $\mathbf{M} = \chi_m \mathbf{H}$ then

$$\begin{aligned}\mathbf{M} &= \mu_0 \mathbf{H} + \mu_0 \mathbf{M} \\ &= \mu_0 (1 + \chi_m) \mathbf{H} \\ &= \mu_0 \mu_r \mathbf{H}\end{aligned}\tag{2.14}$$

so with $\mu_r = 1 + \chi_m$, and $\mu = \mu_0 \mu_r$ we have

$$\mathbf{B} = \mu \mathbf{H}.\tag{2.15}$$

Linear and angular momentum in light It was pointed out that we have two relations in mechanics that relate momentum and forces

$$\begin{aligned}\mathbf{F} &= \frac{d\mathbf{P}}{dt} \\ \boldsymbol{\tau} &= \frac{d\mathbf{L}}{dt},\end{aligned}\tag{2.16}$$

where $\mathbf{P} = m\mathbf{v}$ is the linear momentum, and $\mathbf{L} = \mathbf{r} \times \mathbf{p}$ is the angular momentum. In quantum electrodynamics, the photon can be described using a relationship between wave-vector and momentum

$$\begin{aligned}
\mathbf{p} &= \hbar \mathbf{k} \\
&= \hbar \frac{2\pi}{\lambda} \\
&= \frac{h}{2\pi} \frac{2\pi}{\lambda} \\
&= \frac{h}{\lambda},
\end{aligned} \tag{2.17}$$

where $\hbar = 6.522 \times 10^{-16} \text{ eV s}$.

Photons are also governed by

$$\begin{aligned}
E &= \hbar \omega \\
&= h\nu.
\end{aligned} \tag{2.18}$$

(De-Broglie's relations).

ASIDE: optical fibre at 1550 has the lowest amount of optical attenuation.

Since photons have linear momentum, we can move things around using light. With photons having both linear momentum and energy relationships, and there is a relation between torque and linear momentum, it seems that there must be the possibility of light having angular momentum.

Is it possible to utilize the angular momentum to impose patterns on beams (such as laser beams). For example, what if a beam could have a geometrical pattern along its line of propagation, being off in some regions, on in others. This is in fact possible, generating beams that are "self healing".

The question was posed "Is it possible to solve electromagnetic problems utilizing the force concepts?", using the Lorentz force equation

$$\mathbf{F} = q\mathbf{v} \times \mathbf{B} + q\mathbf{E}. \tag{2.19}$$

This was not thought to be a productive approach due to the complexity.

FIXME: It appeared that this animated talk (probably not captured well) about momentum in light was linked to the idea of the Helmholtz theorem. Exactly how was not clear to me.

Helmholtz's theorem Suppose that we have a linear material where

$$\begin{aligned}
\nabla \times \mathbf{E} &= -\frac{\partial \mathbf{B}}{\partial t} \\
\nabla \times \mathbf{H} &= \mathbf{J} + \frac{\partial \mathbf{D}}{\partial t} \\
\nabla \cdot \mathbf{E} &= \frac{\rho_v}{\epsilon_0} \\
\nabla \cdot \mathbf{H} &= 0
\end{aligned} \tag{2.20}$$

We have relations between the divergence and curl of \mathbf{E} given the sources. Is that sufficient to determine \mathbf{E} itself? The answer is yes, which is due to the Helmholtz theorem.

Extra homework question (bonus) : can knowledge of the tangential components of the fields also be used to uniquely determine \mathbf{E} ?

2.1 PROBLEMS

Exercise 2.1 Displacement current and Ampere's law.

Show that without the displacement current $\partial\mathbf{D}/\partial t$, Maxwell's equations will not satisfy conservation relations.

Answer for Exercise 2.1

PROBLEM SET RELATED MATERIAL REDACTED IN THIS DOCUMENT.PLEASE FEEL FREE TO EMAIL ME FOR THE FULL VERSION IF YOU AREN'T TAKING ECE1228.

REDACTED

END-REDACTION

Exercise 2.2 Electric field due to spherical shell ([5] pr. 2.7)

Calculate the field due to a spherical shell. The field is

$$\mathbf{E} = \frac{\sigma}{4\pi\epsilon_0} \int \frac{(\mathbf{r} - \mathbf{r}')}{|\mathbf{r} - \mathbf{r}'|^3} da', \quad (2.21)$$

where \mathbf{r}' is the position to the area element on the shell. For the test position, let $\mathbf{r} = z\mathbf{e}_3$.

Answer for Exercise 2.2

PROBLEM SET RELATED MATERIAL REDACTED IN THIS DOCUMENT.PLEASE FEEL FREE TO EMAIL ME FOR THE FULL VERSION IF YOU AREN'T TAKING ECE1228.

REDACTED

[REDACTED]
 [REDACTED]
 [REDACTED]
 [REDACTED]. END-REDACTION

Exercise 2.3 Solenoidal fields

For the electric fields graphically shown below indicate whether the fields are solenoidal (divergence free) or not. In the case of non-solenoidal fields indicate the charge generating the field is positive or negative. Justify your answer.

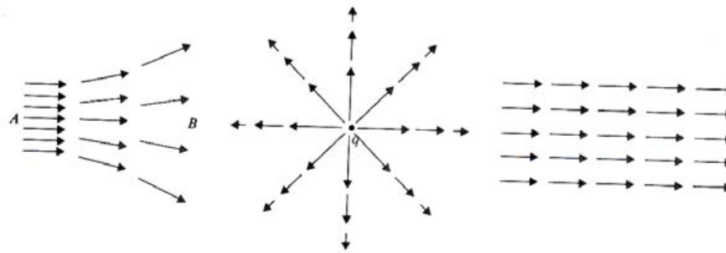

Figure 2.4: Field lines

Answer for Exercise 2.3

PROBLEM SET RELATED MATERIAL REDACTED IN THIS DOCUMENT. PLEASE FEEL FREE TO EMAIL ME FOR THE FULL VERSION IF YOU AREN'T TAKING ECE1228.

[REDACTED]
 [REDACTED]
 [REDACTED]
 [REDACTED]
 [REDACTED]
 [REDACTED]
 [REDACTED]
 [REDACTED]
 [REDACTED]. END-REDACTION

Exercise 2.4 Electric field lines.

Can either or both of the vector fields shown below represent an electrostatic field \mathbf{E} . Justify your answer.

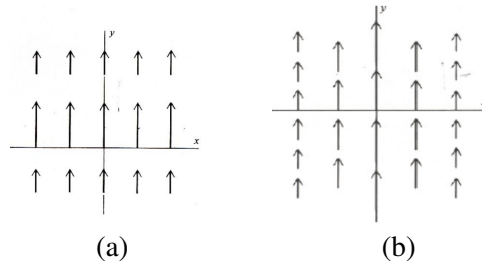

Figure 2.5: Field lines.

Answer for Exercise 2.4

PROBLEM SET RELATED MATERIAL REDACTED IN THIS DOCUMENT.PLEASE FEEL FREE TO EMAIL ME FOR THE FULL VERSION IF YOU AREN'T TAKING ECE1228.

[REDACTED]

END-REDACTION

Exercise 2.5 Solenoidal and irrotational fields.

In terms of \mathbf{E} or \mathbf{H} give an example for each of the following conditions:

- Field is solenoidal and irrotational.
- Field is solenoidal and rotational.
- Field is non-solenoidal and irrotational.
- Field is non-solenoidal and rotational.

Answer for Exercise 2.5

PROBLEM SET RELATED MATERIAL REDACTED IN THIS DOCUMENT.PLEASE FEEL FREE TO EMAIL ME FOR THE FULL VERSION IF YOU AREN'T TAKING ECE1228.

[REDACTED]

END-REDACTION

Exercise 2.6 Conducting sheet with hole.

Figure 2.6. shows a flat, positive, non-conducting sheet of charge with uniform charge density σ [C/m²]. A small circular hole of radius R is cut in the middle of the surface as shown.

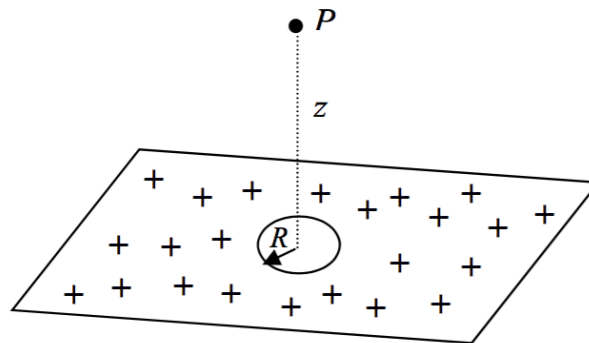

Figure 2.6: Conducting sheet with a hole.

Calculate the electric field intensity \mathbf{E} at point P , a distance z from the centre of the hole along its axis.

Hint 1: Ignore the field fringe effects around all edges. Hint 2: Calculate the field due to a disk of radius R and use superposition.

Answer for Exercise 2.6

PROBLEM SET RELATED MATERIAL REDACTED IN THIS DOCUMENT.PLEASE FEEL FREE TO EMAIL ME FOR THE FULL VERSION IF YOU AREN'T TAKING ECE1228.

END-REDACTION

Exercise 2.7 Helmholtz theorem

Prove the first Helmholtz's theorem, i.e. if vector \mathbf{M} is defined by its divergence

$$\nabla \cdot \mathbf{M} = s \quad (2.22)$$

and its curl

$$\nabla \times \mathbf{M} = \mathbf{C} \quad (2.23)$$

within a region and its normal component M_n over the boundary, then \mathbf{M} is uniquely specified.

Answer for Exercise 2.7

PROBLEM SET RELATED MATERIAL REDACTED IN THIS DOCUMENT.PLEASE FEEL FREE TO EMAIL ME FOR THE FULL VERSION IF YOU AREN'T TAKING ECE1228.

[REDACTED]

END-REDACTION

Exercise 2.8 Waveguide field

The instantaneous electric field inside a conducting parallel plate waveguide is given by

$$\mathcal{E}(\mathbf{r}, t) = \mathbf{e}_2 E_0 \sin\left(\frac{\pi}{a}x\right) \cos(\omega t - \beta_z z) \quad (2.24)$$

where β_z is the waveguide's phase constant and a is the waveguide width (a constant). Assuming there are no sources within the free-space-filled pipe, determine

- The corresponding instantaneous magnetic field components inside the conducting pipe.
- The phase constant β_z .

Answer for Exercise 2.8

PROBLEM SET RELATED MATERIAL REDACTED IN THIS DOCUMENT.PLEASE FEEL FREE TO EMAIL ME FOR THE FULL VERSION IF YOU AREN'T TAKING ECE1228.

[REDACTED]

[REDACTED] END-REDACTION

Exercise 2.9 Infinite line charge.

- An infinitely long straight line charge has a constant charge density ρ_l [C/m].
- Using the integral formulation for \mathbf{E} discussed in the class calculate the electric field at an arbitrary point $\mathbf{A}(\rho, \phi, z)$.
 - Using the Gauss law calculate the same as part a.
 - Now suppose that our uniformly charged (ρ_l constant) has a finite extension from $z = a$ to $z = b$, as sketched in fig. 2.7. Find the electric field at the arbitrary point \mathbf{A} .

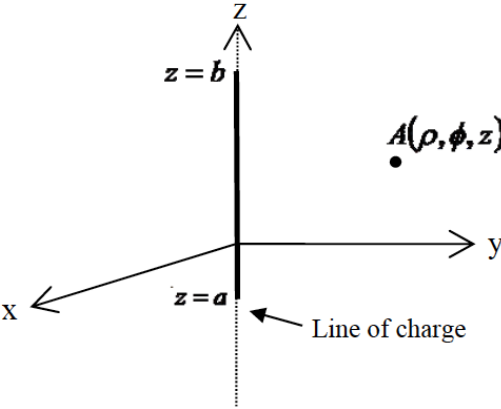

Figure 2.7: Line charge.

Note: Express your results in cylindrical coordinate system.

Answer for Exercise 2.9

PROBLEM SET RELATED MATERIAL REDACTED IN THIS DOCUMENT.PLEASE FEEL FREE TO EMAIL ME FOR THE FULL VERSION IF YOU AREN'T TAKING ECE1228. [REDACTED]

Answer for Exercise 2.11

PROBLEM SET RELATED MATERIAL REDACTED IN THIS DOCUMENT.PLEASE
FEEL FREE TO EMAIL ME FOR THE FULL VERSION IF YOU AREN'T TAKING ECE1228.

[REDACTED]

END-REDACTION

3

ELECTROSTATICS AND DIPOLES.

Polarization and Magnetization The importance of the polarization and magnetization given by

$$\begin{aligned}\mathbf{D} &= \epsilon_0 \mathbf{E} + \mathbf{P} \\ \mathbf{P} &= \epsilon_0 \chi_e \mathbf{E},\end{aligned}\tag{3.1}$$

where

$$\begin{aligned}\mathbf{D} &= \epsilon \mathbf{E} \\ \epsilon &= \epsilon_0 \epsilon_r \\ \epsilon_r &= 1 + \chi_e.\end{aligned}\tag{3.2}$$

Point charge.

$$\begin{aligned}\mathbf{E} &= \frac{q}{4\pi\epsilon_0} \frac{\hat{\mathbf{r}}}{r^2} \\ &= \frac{q}{4\pi\epsilon_0} \frac{\mathbf{r}}{|\mathbf{r}|^3} \\ &= \frac{q}{4\pi\epsilon_0} \frac{\mathbf{r}}{r^3}.\end{aligned}\tag{3.3}$$

In more complex media the ϵ_0 here can be replaced by ϵ . Here the vector \mathbf{r} points from the charge to the observation point.

Note that the class notes use \hat{a}_R instead of $\hat{\mathbf{r}}$.

When the charge isn't located at the origin, we must modify this accordingly

$$\begin{aligned}\mathbf{E} &= \frac{q}{4\pi\epsilon_0} \frac{\mathbf{R}}{|\mathbf{R}|^3} \\ &= \frac{q}{4\pi\epsilon_0} \frac{\mathbf{R}}{R^3},\end{aligned}\tag{3.4}$$

where $\mathbf{R} = \mathbf{r} - \mathbf{r}'$ still points from the location of the charge to the point of observation, as sketched in fig. 3.1.

This can be further generalized to collections of point charges by superposition

$$\mathbf{E} = \frac{1}{4\pi\epsilon_0} \sum_i q_i \frac{\mathbf{r} - \mathbf{r}'_i}{|\mathbf{r} - \mathbf{r}'_i|^3}.\tag{3.5}$$

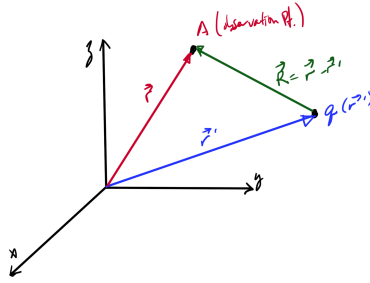

Figure 3.1: Vector distance from charge to observation point.

Observe that a potential that satisfies $\mathbf{E} = -\nabla V$ can be defined as

$$V = \frac{1}{4\pi\epsilon_0} \sum_i \frac{q_i}{|\mathbf{r} - \mathbf{r}'_i|}. \quad (3.6)$$

When we are considering real world scenarios (like touching your hair, and then the table), how do we deal with the billions of charges involved. This can be done by considering the charges so small that they can be approximated as a continuous distribution of charges.

This can be done by introducing the concept of a continuous charge distribution $\rho_v(\mathbf{r}')$. The charge that is in a small differential volume element dV' is $\rho_v(\mathbf{r}')dV'$, and the superposition has the form

$$\mathbf{E} = \frac{1}{4\pi\epsilon_0} \iiint dV' \rho_v(\mathbf{r}') \frac{\mathbf{r} - \mathbf{r}'}{|\mathbf{r} - \mathbf{r}'|^3}, \quad (3.7)$$

with potential

$$V = \frac{1}{4\pi\epsilon_0} \iiint dV' \frac{\rho_v(\mathbf{r}')}{|\mathbf{r} - \mathbf{r}'|}. \quad (3.8)$$

The surface charge density analogue of this is

$$\mathbf{E} = \frac{1}{4\pi\epsilon_0} \iint dA' \rho_s(\mathbf{r}') \frac{\mathbf{r} - \mathbf{r}'}{|\mathbf{r} - \mathbf{r}'|^3}, \quad (3.9)$$

with potential

$$V = \frac{1}{4\pi\epsilon_0} \iint dA' \frac{\rho_s(\mathbf{r}')}{|\mathbf{r} - \mathbf{r}'|}. \quad (3.10)$$

The line charge density analogue of this is

$$\mathbf{E} = \frac{1}{4\pi\epsilon_0} \int dl' \rho_l(\mathbf{r}') \frac{\mathbf{r} - \mathbf{r}'}{|\mathbf{r} - \mathbf{r}'|^3}, \quad (3.11)$$

with potential

$$V = \frac{1}{4\pi\epsilon_0} \int dl' \frac{\rho_1(\mathbf{r}')}{|\mathbf{r} - \mathbf{r}'|}. \quad (3.12)$$

The difficulty with any of these approaches is the charge density is hardly ever known. When the charge density is known, this sorts of integrals may not be analytically calculable, but they do yield to numeric calculation.

We may often prefer the potential calculations of the field calculations because they are much easier, having just one component to deal with.

Electric field of a dipole. An equal charge dipole configuration is sketched in fig. 3.2.

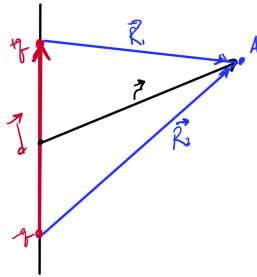

Figure 3.2: Dipole sign convention.

$$\begin{aligned} \mathbf{r}_1 &= \mathbf{r} - \frac{\mathbf{d}}{2} \\ \mathbf{r}_2 &= \mathbf{r} + \frac{\mathbf{d}}{2} \end{aligned} \quad (3.13)$$

The electric field is

$$\begin{aligned} \mathbf{E} &= \frac{q}{4\pi\epsilon_0} \left(\frac{\mathbf{r}_1}{r_1^3} - \frac{\mathbf{r}_2}{r_2^3} \right) \\ &= \frac{q}{4\pi\epsilon_0} \left(\frac{\mathbf{r} - \mathbf{d}/2}{|\mathbf{r} - \mathbf{d}/2|^3} - \frac{\mathbf{r} + \mathbf{d}/2}{|\mathbf{r} + \mathbf{d}/2|^3} \right) \end{aligned} \quad (3.14)$$

For $r \gg |\mathbf{d}|$, this can be reduced using the normal first order reduction techniques, left to an exercise.

This is essentially requires an expansion of

$$|\mathbf{r} \pm \mathbf{d}/2|^{-3/2} = ((\mathbf{r} \pm \mathbf{d}/2) \cdot (\mathbf{r} \pm \mathbf{d}/2))^{-3/2} \quad (3.15)$$

The final result with $\mathbf{p} = q\mathbf{d}$ (the dipole moment) can be found to be

$$\mathbf{E} = \frac{1}{4\pi\epsilon_0 r^3} \left(3 \frac{\mathbf{r} \cdot \mathbf{p}}{r^2} \mathbf{r} - \mathbf{p} \right) \quad (3.16)$$

With $\mathbf{p} = q\hat{\mathbf{z}}$, we have spherical coordinates for the observation point, and Cartesian for the dipole moment. To convert the moment to spherical we can use

$$\begin{bmatrix} A_r \\ A_\theta \\ A_\phi \end{bmatrix} = \begin{bmatrix} \sin \theta \cos \phi & \sin \theta \sin \phi & \cos \theta \\ \cos \theta \cos \phi & \cos \theta \sin \phi & -\sin \theta \\ -\sin \phi & \cos \phi & 0 \end{bmatrix} \begin{bmatrix} A_x \\ A_y \\ A_z \end{bmatrix}. \quad (3.17)$$

All such rotation matrices can be found in the appendix of [2] for example. For the dipole vector this gives

$$\begin{bmatrix} p_r \\ p_\theta \\ p_\phi \end{bmatrix} = \begin{bmatrix} \cos \theta p \\ -\sin \theta p \\ 0 \end{bmatrix}. \quad (3.18)$$

or

$$\mathbf{p} = p\hat{\mathbf{z}} = p(\cos \theta \hat{\mathbf{r}} - \sin \theta \hat{\theta}) \quad (3.19)$$

Plugging in this eventually gives

$$\mathbf{E} = \frac{p}{4\pi\epsilon_0 r^3} (2 \cos \theta \hat{\mathbf{r}} + \sin \theta \hat{\theta}), \quad (3.20)$$

where $|\mathbf{r}| = r$.

It will be left to a problem to show that the potential for an electric dipole is given by

$$V = \frac{\mathbf{p} \cdot \hat{\mathbf{r}}}{4\pi\epsilon_0 r^2}. \quad (3.21)$$

Observe that the dipole field drops off faster than the field for a single electric charge. This is true generally, with quadrupole and higher order moments dropping off faster as the degree is increased.

Potentials due to bound (polarized) surface and volume charge densities. When an electric field is applied to a volume, bound charges are induced on the surface of the material, and bound charges induced in the volume. Both of these are related to the polarization \mathbf{P} , and the displacement current in the material, in a configuration such as the capacitor sketched in fig. 3.3.

Consider, for example, a capacitor using glass as a dielectric. The charges are not able to move within the insulating material, but dipole configurations can be induced on the surface and in the bulk of the material, as sketched in fig. 3.4.

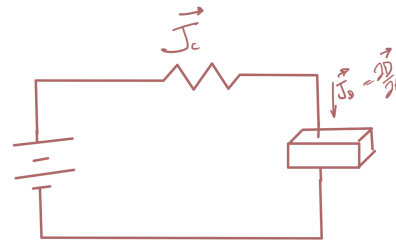

Figure 3.3: Circuit with displacement current.

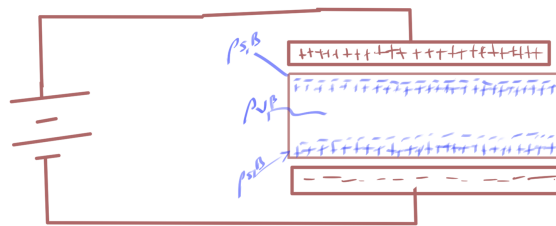

Figure 3.4: Glass dielectric capacitor bound charge dipole configurations.

How many materials behave is largely determined by electric dipole effects. In particular, the polarization \mathbf{P} can be considered the density of electric dipoles.

$$\mathbf{P} = \lim_{\Delta v' \rightarrow 0} \sum_k^{N\Delta v'} \frac{\mathbf{p}_k}{\Delta v'}, \tag{3.22}$$

where N is the number density in the volume at that point, and $\Delta v'$ is the differential volume element. Dimensions:

- $[\mathbf{p}] = \text{C m}$
- $[\mathbf{P}] = \text{C/m}^2$

In particular, when the electron cloud density of a material is not symmetric, as is the case in the p-orbital roughly sketched in fig. 3.5, then we have a dipole configuration in each atom. When the atom is symmetric, by applying an electric field, a dipole configuration can be created. As the volume shrinks to zero, the dipole moment can be expressed as

$$\mathbf{P} = \frac{d\mathbf{p}}{dv}. \tag{3.23}$$

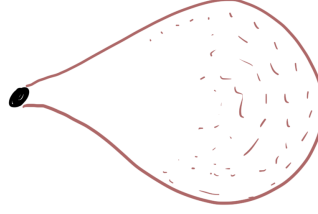

Figure 3.5: A p-orbital dipole like electronic configuration.

For an elemental dipole $d\mathbf{p} = \mathbf{P}dv'$, the contribution to the potential is

$$\begin{aligned} dV &= \frac{d\mathbf{p} \cdot \hat{\mathbf{r}}}{4\pi\epsilon_0 R^2} \\ &= \frac{\mathbf{P} \cdot \hat{\mathbf{r}}}{4\pi\epsilon_0 R^2} dv' \end{aligned} \quad (3.24)$$

Since

$$\nabla' \frac{1}{R} = \frac{\hat{\mathbf{r}}}{R^2}, \quad (3.25)$$

this can be written as

$$\begin{aligned} V &= \frac{1}{4\pi\epsilon_0} \int_{v'} dv' \mathbf{P} \cdot \nabla' \frac{1}{R} \\ &= \frac{1}{4\pi\epsilon_0} \int_{v'} dv' \nabla' \cdot \frac{\mathbf{P}}{R} - \frac{1}{4\pi\epsilon_0} \int_{v'} dv' \frac{\nabla' \cdot \mathbf{P}}{R} \\ &= \frac{1}{4\pi\epsilon_0} \left(\oint_{S'} ds' \hat{\mathbf{n}} \cdot \frac{\mathbf{P}}{R} - \int_{v'} dv' \frac{\nabla' \cdot \mathbf{P}}{R} \right) \end{aligned} \quad (3.26)$$

Looking back to the potentials in their volume density eq. (3.8) and surface charge density eq. (3.9) forms, we see that identifications can be made with the volume and surface charge densities

$$\begin{aligned} \rho'_s &= \mathbf{P} \cdot \hat{\mathbf{n}} \\ \rho'_v &= \nabla' \cdot \mathbf{P} \end{aligned} \quad (3.27)$$

Dropping primes, these are respectively

- Bound or polarized surface charge density: $\rho_{sP} = \mathbf{P} \cdot \hat{\mathbf{n}}$, in $[\text{C}/\text{m}^2]$

- Bound or polarized volume charge density: $\rho_{vP} = \nabla \cdot \mathbf{P}$, in $[\text{C}/\text{m}^3]$

Recall that in Maxwell's equations for the vacuum we have

$$\nabla \cdot \mathbf{E} = \frac{\rho_v}{\epsilon_0}. \quad (3.28)$$

Here ρ_v represents “free” charge density. Adding in potential bound charges we have

$$\begin{aligned} \nabla \cdot \mathbf{E} &= \frac{\rho_v}{\epsilon_0} + \frac{\rho_{vP}}{\epsilon_0} \\ &= \frac{\rho_v}{\epsilon_0} - \frac{\nabla \cdot \mathbf{P}}{\epsilon_0}. \end{aligned} \quad (3.29)$$

Rearranging we can write

$$\nabla \cdot (\epsilon_0 \mathbf{E} + \mathbf{P}) = \rho_v. \quad (3.30)$$

This finally justifies the Maxwell equation

$$\nabla \cdot \mathbf{D} = \rho_v, \quad (3.31)$$

where $\mathbf{D} = \epsilon_0 \mathbf{E} + \mathbf{P}$.

Assuming a relationship between the polarization vector and the electric field of the form

$$\mathbf{P} = \epsilon_0 \chi_e \mathbf{E}, \quad (3.32)$$

possibly a tensor relationship. The bound charges in the material are seen to related the displacement current and the electric field

$$\begin{aligned} \mathbf{D} &= \epsilon_0 \mathbf{E} + \mathbf{P} \\ &= \epsilon_0 \mathbf{E} + \epsilon_0 \chi_e \mathbf{E}, \\ &= \epsilon_0 (1 + \chi_e) \mathbf{E}, \\ &= \epsilon_0 \epsilon_r \mathbf{E}, \\ &= \epsilon \mathbf{E}. \end{aligned} \quad (3.33)$$

Question: Think about why do we ignore the surface charges here? Answer: we are not considering boundaries... they are at infinity.

3.1 PROBLEMS

Exercise 3.1 Electric Dipole.

An electric dipole is shown in fig. 3.6.

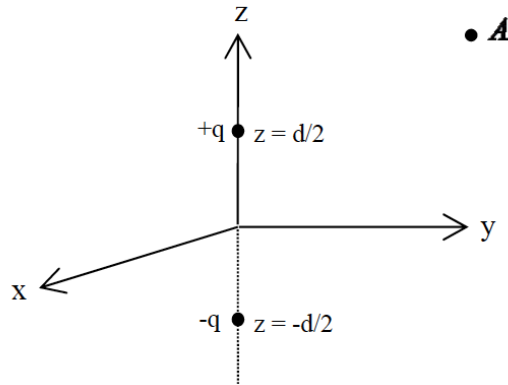

Figure 3.6: Electric dipole configuration.

- a. Find the Potential V at an arbitrary point A .
- b. Calculate the field \mathbf{E} from the above potential.
(show that it is the same result we obtained in the class).

Answer for Exercise 3.1

PROBLEM SET RELATED MATERIAL REDACTED IN THIS DOCUMENT.PLEASE
FEEL FREE TO EMAIL ME FOR THE FULL VERSION IF YOU AREN'T TAKING ECE1228.

[REDACTED]

[REDACTED]. END-REDACTION

Exercise 3.2 Dipole moment density for disk.

[REDACTED]

END-REDACTION

Exercise 3.4 Electric dipole potential

Having shown that

$$\mathbf{E} = \frac{1}{4\pi\epsilon_0 r^3} (3\hat{\mathbf{r}}(\hat{\mathbf{r}} \cdot \mathbf{p}) - \mathbf{p}), \quad (3.34)$$

find the expression for the electric potential for this field.

Answer for Exercise 3.4

PROBLEM SET RELATED MATERIAL REDACTED IN THIS DOCUMENT. PLEASE FEEL FREE TO EMAIL ME FOR THE FULL VERSION IF YOU AREN'T TAKING ECE1228. [REDACTED]

[REDACTED]

END-REDACTION

4

MAGNETIC MOMENT, AND BOUNDARY VALUE CONDITIONS

Magnetic moment. Using a semi-classical model of an electron, assuming that the electron circles the nuclei. This is a completely wrong model, but useful. In reality, electrons are random and probabilistic and do not follow defined paths. We do however have a magnetic moment associated with the electron, and one associated with the spin of the electron, and a moment associated with the spin of the nuclei. All of these concepts can be used to describe a more accurate model and such a model is discussed in [8] chapters 11,12,13.

Ignoring the details of how the moments really occur physically, we can take it as a given that they exist, and model them as elemental magnetic dipole moments of the form

$$d\mathbf{m}_i = \hat{\mathbf{n}}_i I_i ds_i \quad [\text{Am}^2]. \quad (4.1)$$

Note that ds_i is an element of surface area, not arc length!

Here the normal is defined in terms of the right hand rule with respect to the direction of the current as sketched in fig. 4.1.

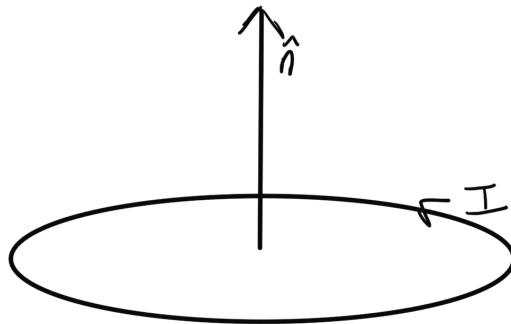

Figure 4.1: Orientation of current loop.

Such dipole moments are actually what an MRI measures. The noises that people describe from MRI machines are actually when the very powerful magnets are being rotated, allowing for the magnetic moments in the atoms of the body to be measured in different directions.

The magnetic polarization, or magnetization \mathbf{M} , in [A/m] is given by

$$\begin{aligned}
\mathbf{M} &= \lim_{\Delta v \rightarrow 0} \left(\frac{1}{\Delta v} \mathbf{m}_i \right) \\
&= \lim_{\Delta v \rightarrow 0} \left(\frac{1}{\Delta v} \sum_{i=1}^{N\delta v} d\mathbf{m}_i \right) \\
&= \lim_{\Delta v \rightarrow 0} \left(\frac{1}{\Delta v} \sum_{i=1}^{N\delta v} \hat{\mathbf{n}}_i I_i ds_i \right).
\end{aligned} \tag{4.2}$$

In materials the magnetization within the atoms are usually random, however, application of a magnetic field can force these to line up, as sketched in fig. 4.2.

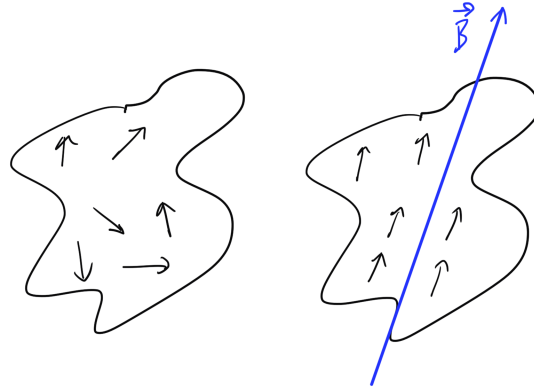

Figure 4.2: External magnetic field alignment of magnetic moments.

This is accomplished because an applied magnetic field acting on the magnetic moment introduces a torque, as also occurred with dipole moments under applied electric fields

$$\begin{aligned}
\boldsymbol{\tau}_B &= d\mathbf{m} \times \mathbf{B}_a \\
\boldsymbol{\tau}_E &= d\mathbf{p} \times \mathbf{E}_a.
\end{aligned} \tag{4.3}$$

There is an energy associated with this torque

$$\begin{aligned}
\Delta U_B &= -d\mathbf{m} \cdot \mathbf{B}_a \\
\Delta U_E &= -d\mathbf{p} \cdot \mathbf{E}_a.
\end{aligned} \tag{4.4}$$

In analogy with the electric dipole moment analysis, it can be assumed that there is a linear relationship between the magnetic polarization and the applied magnetic field

$$\begin{aligned}
\mathbf{B} &= \mu_0 \mathbf{H}_a + \mu_0 \mathbf{M} \\
&= \mu_0 (\mathbf{H}_a + \mathbf{M}),
\end{aligned} \tag{4.5}$$

where

$$\mathbf{M} = \chi_m \mathbf{H}_a, \quad (4.6)$$

so

$$\mathbf{B} = \mu_0 (1 + \chi_m) \mathbf{H}_a \equiv \mu \mathbf{H}_a. \quad (4.7)$$

Like electric dipoles, in a volume, we can have bound currents on the surface [A/m], as well as bound volume currents [A/m²].

It can be shown, as with the electric dipoles related bound charge densities of eq. (3.27), that magnetic currents can be defined

$$\begin{aligned} \mathbf{J}_{sm} &= \mathbf{M} \times \hat{\mathbf{n}} \\ \mathbf{J}_{vm} &= \nabla \times \mathbf{M}, \end{aligned} \quad (4.8)$$

Conductivity We have two constitutive relationships so far

$$\begin{aligned} \mathbf{D} &= \epsilon \mathbf{E} \\ \mathbf{B} &= \mu \mathbf{H} \end{aligned} \quad (4.9)$$

but this needs to be augmented by

$$\mathbf{J}_c = \epsilon \mathbf{E}. \quad (4.10)$$

There are a couple ways to discuss this. One is to model ϵ as a complex number. Such a model is not entirely unconstrained. Like with the Cauchy-Riemann conditions that relate derivatives of the real and imaginary parts of a complex number, there is a relationship (Kramers-Kronig [10]), an integral relationship that relates the real and imaginary parts of the permittivity ϵ .

Boundary conditions. The boundary conditions are

- $\hat{\mathbf{n}} \times (\mathbf{E}_2 - \mathbf{E}_1) = -\mathbf{M}_s$ This means that the tangential components of \mathbf{E} is continuous across the boundary (those components of $\mathbf{E}_1, \mathbf{E}_2$ are equal on the boundary), when \mathbf{M}_s is zero.

Here \mathbf{M}_s is the (fictitious) magnetic current density in [V/m].

- $\hat{\mathbf{n}} \times (\mathbf{H}_2 - \mathbf{H}_1) = \mathbf{J}_s$

This means that the tangential components of the magnetic fields \mathbf{H} are discontinuous when the electric surface current density \mathbf{J}_s [A/m] is non-zero, but continuous otherwise. The latter is sketched in fig. 4.3.

Here \mathbf{J}_s is the movement of the free current on the surface. The bound charges are incorporated into \mathbf{D} .

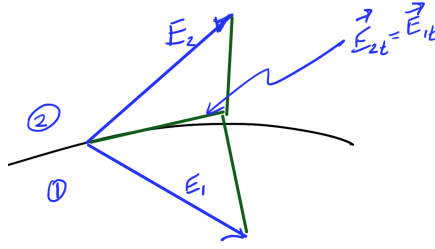

Figure 4.3: Equal tangential fields.

- $\hat{\mathbf{n}} \cdot (\mathbf{D}_2 - \mathbf{D}_1) = \rho_{es}$

Here ρ_{es} is the electric surface charge density [C/m^2].

This means that the normal component of the electric displacement field \mathbf{D} is discontinuous across the boundary in the presence of electric surface charge densities, but continuous when that is zero.

- $\hat{\mathbf{n}} \cdot (\mathbf{B}_2 - \mathbf{B}_1) = \rho_{ms}$

Here ρ_{ms} is the (fictional) magnetic surface charge density [Weber/m^2].

This means that the magnetic fields \mathbf{B} are continuous in the absence of (fictional) magnetic surface charge densities.

In the absence of any free charges or currents, these relationships are considerably simplified

$$\hat{\mathbf{n}} \times (\mathbf{E}_2 - \mathbf{E}_1) = 0 \quad (4.11a)$$

$$\hat{\mathbf{n}} \times (\mathbf{H}_2 - \mathbf{H}_1) = 0 \quad (4.11b)$$

$$\hat{\mathbf{n}} \cdot (\mathbf{D}_2 - \mathbf{D}_1) = 0 \quad (4.11c)$$

$$\hat{\mathbf{n}} \cdot (\mathbf{B}_2 - \mathbf{B}_1) = 0 \quad (4.11d)$$

To get an idea where these come from, consider the derivation of eq. (4.11b), relating the tangential components of \mathbf{H} , as sketched in fig. 4.4.

Integrating over such a loop, the integral version of the Ampere-Maxwell equation eq. (1.2), with $\mathbf{J} = \sigma\mathbf{E}$ is

$$\oint_C \mathbf{H} \cdot d\mathbf{l} = \int_S \sigma\mathbf{E} \cdot d\mathbf{s} + \frac{\partial}{\partial t} \int_S \mathbf{D} \cdot d\mathbf{s}. \quad (4.12)$$

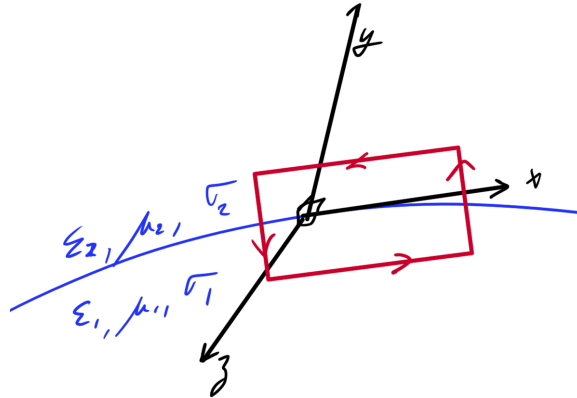

Figure 4.4: Boundary geometry.

In the limit, with the height $\Delta y \rightarrow 0$, this is

$$\oint_C \mathbf{H} \cdot d\mathbf{l} \approx H_1 \cdot (\Delta x \hat{\mathbf{x}}) - H_2 \cdot (\Delta x \hat{\mathbf{x}}) \quad (4.13)$$

Similarly

$$\int_S \mathbf{D} \cdot d\mathbf{s} \approx \mathbf{D} \cdot \hat{\mathbf{z}} \Delta x \Delta y, \quad (4.14)$$

and

$$\int_S \mathbf{J} \cdot d\mathbf{s} = \int_S \sigma \mathbf{E} \cdot d\mathbf{s} \approx \sigma \mathbf{E} \cdot \hat{\mathbf{z}} \Delta x \Delta y, \quad (4.15)$$

However, if Δy approaches zero, both of these terms are killed.

This gives

$$\hat{\mathbf{x}} \cdot (\mathbf{H}_2 - \mathbf{H}_1) = 0. \quad (4.16)$$

If you were to perform the same calculation using a loop in the y-z plane you'd find

$$\hat{\mathbf{z}} \cdot (\mathbf{H}_2 - \mathbf{H}_1) = 0. \quad (4.17)$$

Either way, the tangential component of \mathbf{H} is continuous on the boundary.

This derivation, using explicit components, follows [2]. Non coordinate derivations are also possible (reference?).

The idea is that

$$\begin{aligned}\hat{\mathbf{n}} \times ((\mathbf{H}_2 - \mathbf{H}_{2n}) - (\mathbf{H}_1 - \mathbf{H}_{1n})) &= \hat{\mathbf{n}} \times (\mathbf{H}_2 - \mathbf{H}_1) \\ &= 0.\end{aligned}\tag{4.18}$$

What if there is a surface current?

$$\lim_{\Delta y \rightarrow 0} \mathbf{J}_{ic} \Delta y = \mathbf{J}_s.\tag{4.19}$$

When this is the case the $\mathbf{J} = \sigma \mathbf{E}$ needs to be fixed up a bit, and showing how is left to a problem.

In the notes the other boundary relations are derived. The normal ones follow by integrating over a pillbox volume.

Variations include the cases when one of the surfaces is made a perfect conductor. Such a case can be treated by noting that the \mathbf{E} field must be zero.

Conducting media. It will be left to homework to show, using the continuity equation and Gauss's law that inside a conductor, that free charges distribute themselves exclusively on the surface on the medium. Because of this there is no electric field inside the medium (Gauss's law). What does this imply about the magnetic field in the same medium. We must have

$$\nabla \times \mathbf{E} = -\frac{\partial \mathbf{B}}{\partial t}\tag{4.20}$$

so if \mathbf{E} is zero in the medium the magnetic field must be either constant with respect to time, or zero. In a general electrodynamic configuration, both the magnetic and electric fields vary with time, which seems to imply that \mathbf{B} must be zero if \mathbf{E} is zero in that space.

However, this is not consistent with what we see with an iron core inductor. In such an inductor, the iron is used to concentrate the magnetic field. Clearly we have magnetic fields in the iron bar, since that is the purpose of it being there. It turns out that if the frequencies are low enough (and even some smaller GHz frequencies are), then we can consider the system to be quasi-electrostatic, with zero electric fields inside a conductor, yet with finite approximately time independent magnetic fields. As the frequencies are increased, the magnetic fields are forced out of the conductor into the surrounding space.

The transition point that defines the boundary between electrostatic and quasi-electrostatic will depend on the precision desired.

Boundary conditions with zero magnetic fields in a conductor For many calculations, we can proceed with the assumption that there are no appreciable electric nor magnetic fields inside of a conductor. When that is the case, outside of a conducting medium, we have

$$\hat{\mathbf{n}} \times \mathbf{E}_2 = 0,\tag{4.21}$$

so there is no tangential component to an electric field of a conductor. We also have

$$\hat{\mathbf{n}} \cdot \mathbf{D}_2 = \rho_{es} \quad (4.22)$$

Assuming there is also no magnetic field either in the conductor, we also have

$$\hat{\mathbf{n}} \times \mathbf{H}_2 = \mathbf{J}_s, \quad (4.23)$$

and

$$\hat{\mathbf{n}} \cdot \mathbf{B}_2 = 0. \quad (4.24)$$

There is no normal component to the magnetic field at the surface of a conductor, and the tangential component is determined by the surface current density.

4.1 PROBLEMS

Exercise 4.1 Magnetic moment for localized current.

Jackson [8] §5.6 derives an expression for the magnetic moment of a localized current distribution, far from the source. Repeat this derivation, filling in the details.

Answer for Exercise 4.1

PROBLEM SET RELATED MATERIAL REDACTED IN THIS DOCUMENT.PLEASE
FEEL FREE TO EMAIL ME FOR THE FULL VERSION IF YOU AREN'T TAKING ECE1228.

[REDACTED]

END-REDACTION

Exercise 4.2 Vector Area. ([5] pr. 1.61)

The integral

$$\mathbf{a} = \int_S d\mathbf{a}, \quad (4.25)$$

is sometimes called the vector area of the surface S .

- Find the vector area of a hemispherical bowl of radius R .

- b. Show that $\mathbf{a} = 0$ for any closed surface.
- c. Show that \mathbf{a} is the same for all surfaces sharing the same boundary.
- d. Show that

$$\mathbf{a} = \frac{1}{2} \oint \mathbf{r} \times d\mathbf{l}, \tag{4.26}$$

where the integral is around the boundary line.

- e. Show that

$$\oint (\mathbf{c} \cdot \mathbf{r}) d\mathbf{l} = \mathbf{a} \times \mathbf{c}. \tag{4.27}$$

Answer for Exercise 4.2

PROBLEM SET RELATED MATERIAL REDACTED IN THIS DOCUMENT. PLEASE FEEL FREE TO EMAIL ME FOR THE FULL VERSION IF YOU AREN'T TAKING ECE1228.

[REDACTED]

[REDACTED]

[REDACTED]

[REDACTED]

[REDACTED]

[REDACTED]

[REDACTED]

[REDACTED]

[REDACTED]. END-REDACTION

Exercise 4.3 Tangential magnetic field boundary conditions.

In the class notes we showed that when there were no sources at the interface between two media and neither of the two media was a perfect conductor $\sigma_1, \sigma_2 \neq \infty$ the boundary condition on the tangential magnetic field was given by

$$\hat{\mathbf{n}} \times (\mathbf{H}_2 - \mathbf{H}_1) = 0. \tag{4.28}$$

Here, show that when $\mathbf{J}_i + \mathbf{J}_c = \mathbf{J}_{ic} \neq 0$, the boundary condition is given by

$$\hat{\mathbf{n}} \times (\mathbf{H}_2 - \mathbf{H}_1) = \mathbf{J}_s, \tag{4.29}$$

where

$$\mathbf{J}_s = \lim_{\Delta y \rightarrow 0} \mathbf{J}_{ic} \Delta y. \tag{4.30}$$

Note: Use the geometry provided in fig. 4.5 for your proof.

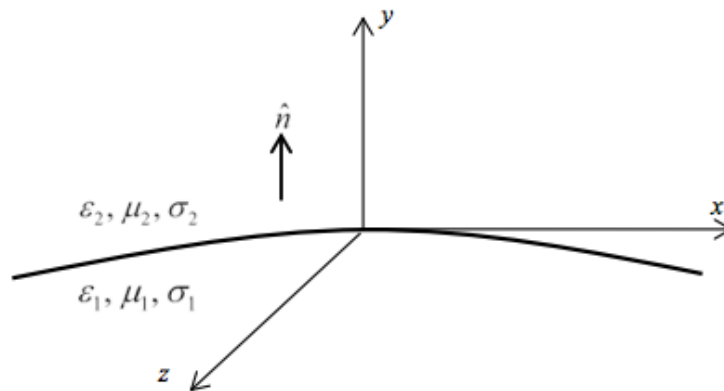

Figure 4.5: Boundary geometry.

Answer for Exercise 4.3

PROBLEM SET RELATED MATERIAL REDACTED IN THIS DOCUMENT.PLEASE
FEEL FREE TO EMAIL ME FOR THE FULL VERSION IF YOU AREN'T TAKING ECE1228.

[REDACTED]

END-REDACTION

Exercise 4.4 Magnetic field for a current loop.

A loop of wire located in x - y plane carrying current I is shown in fig. 4.6. The loop's radius is R_l .

- Calculate the magnetic field flux density, \mathbf{B} , along the loop axis at a distance z from its centre.
- Simplify the results in part a for large distances along the z -axis ($z \gg R_l$).
- Express the results in part b in terms of magnetic dipole moment. Make sure you write the expression in vector form.
- In keeping with your understanding of magnetic bar's north and south poles, designate the north and south poles for the current carrying loop shown in the figure.

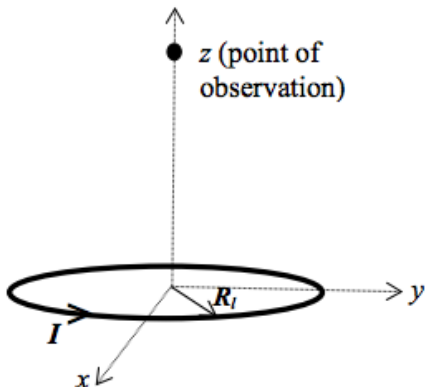

Figure 4.6: Current loop.

Hint: Use Biot-Savart law which states the following: A differential current element, Idl' , produces a differential magnetic field, $d\mathbf{B}$, at a distance R from the current element given by

$$d\mathbf{B} = \frac{\mu_0}{4\pi} \frac{Idl' \times \mathbf{R}}{R^3}, \tag{4.31}$$

or

$$\mathbf{B} = \frac{\mu_0}{4\pi} \int \frac{Idl' \times \mathbf{R}}{R^3}, \tag{4.32}$$

Note that integration is carried over the source (current) and R points from the current elements to the point of observation.

Answer for Exercise 4.4

PROBLEM SET RELATED MATERIAL REDACTED IN THIS DOCUMENT.PLEASE FEEL FREE TO EMAIL ME FOR THE FULL VERSION IF YOU AREN'T TAKING ECE1228.

REDACTED CONTENT

END-REDACTION

Exercise 4.5 Electric field across dielectric boundary.

The plane $3x + 2y + z = 12$ [m] describes the interface between a dielectric and free space. The origin side of the interface has $\epsilon_{r1} = 3$ and $\mathbf{E}_1 = 2\hat{\mathbf{x}} + 5\hat{\mathbf{z}}$ [V/m]. What is \mathbf{E}_2 (the field on the other side of the interface)?

Answer for Exercise 4.5

PROBLEM SET RELATED MATERIAL REDACTED IN THIS DOCUMENT.PLEASE FEEL FREE TO EMAIL ME FOR THE FULL VERSION IF YOU AREN'T TAKING ECE1228.

REDACTED

END-REDACTION

Exercise 4.6 Laplacian form of delta function.

Prove that

$$-\nabla^2 \frac{1}{r} = 4\pi\delta^3(\mathbf{r}), \quad (4.33)$$

where $r = |\mathbf{r}|$ is the position vector.

Answer for Exercise 4.6

PROBLEM SET RELATED MATERIAL REDACTED IN THIS DOCUMENT.PLEASE FEEL FREE TO EMAIL ME FOR THE FULL VERSION IF YOU AREN'T TAKING ECE1228.

REDACTED

END-REDACTION

Exercise 4.7 Conductor charge distribution on surface.

We have stated that the boundary condition for a perfect conductor is such that there is no electric field or charge distribution inside of the conductor. Here we will study the dynamics

of this process. Start with continuity equation $\nabla \cdot \mathbf{J} = -\partial\rho/\partial t$, where \mathbf{J} is the current density [A/m²] and ρ is the charge density [C/m³]. Show that a charge (charge density) placed inside a conductor will decay in an exponential manner.

Answer for Exercise 4.7

PROBLEM SET RELATED MATERIAL REDACTED IN THIS DOCUMENT.PLEASE FEEL FREE TO EMAIL ME FOR THE FULL VERSION IF YOU AREN'T TAKING ECE1228.

[REDACTED]

END-REDACTION

Exercise 4.8 Magnetic field from moment.

The vector potential, to first order, for a magnetostatic localized current distribution was found to be

$$\mathbf{A}(\mathbf{x}) = \frac{\mu_0}{4\pi} \frac{\mathbf{m} \times \mathbf{x}}{|\mathbf{x}|^3}. \quad (4.34)$$

Use this to calculate the magnetic field.

Answer for Exercise 4.8

PROBLEM SET RELATED MATERIAL REDACTED IN THIS DOCUMENT.PLEASE FEEL FREE TO EMAIL ME FOR THE FULL VERSION IF YOU AREN'T TAKING ECE1228.

[REDACTED]

END-REDACTION

5

POYNTING VECTOR, AND TIME HARMONIC (PHASOR) FIELDS.

Poynting The cross product terms of Maxwell's equation are

$$\nabla \times \mathbf{E} = -\mathbf{M}_i - \frac{\partial \mathbf{B}}{\partial t} = -\mathbf{M}_i - \mathbf{M}_d, \quad (5.1)$$

where \mathbf{M}_d is called the magnetic displacement current here. For the magnetic curl we have

$$\nabla \times \mathbf{H} = \mathbf{J}_i + \mathbf{J}_c + \frac{\partial \mathbf{D}}{\partial t} = \mathbf{J}_i + \mathbf{J}_c + \mathbf{J}_d. \quad (5.2)$$

It is left as an exercise to show that

$$\nabla \cdot (\mathbf{E} \times \mathbf{H}) + \mathbf{H} \cdot (\mathbf{M}_i + \mathbf{M}_d) + \mathbf{E} \cdot (\mathbf{J}_i + \mathbf{J}_c + \mathbf{J}_d) = 0, \quad (5.3)$$

or

$$\oint d\mathbf{a} \cdot (\mathbf{E} \times \mathbf{H}) + \int dV (\mathbf{H} \cdot (\mathbf{M}_i + \mathbf{M}_d) + \mathbf{E} \cdot (\mathbf{J}_i + \mathbf{J}_c + \mathbf{J}_d)) = 0, \quad (5.4)$$

or

$$\begin{aligned} 0 &= \oint d\mathbf{a} \cdot (\mathbf{E} \times \mathbf{H}) \\ &+ \int dV \mathbf{H} \cdot \mathbf{M}_i + \int dV \mathbf{E} \cdot \mathbf{J}_i + \int dV \mathbf{E} \cdot \mathbf{J}_c \\ &+ \int dV \left(\mathbf{H} \cdot \frac{\partial \mathbf{B}}{\partial t} + \mathbf{E} \cdot \frac{\partial \mathbf{D}}{\partial t} \right). \end{aligned} \quad (5.5)$$

Define a supplied power density ρ_{supp}

$$-\rho_{\text{supp}} = \int dV \mathbf{H} \cdot \mathbf{M}_i + \int dV \mathbf{E} \cdot \mathbf{J}_i. \quad (5.6)$$

When the medium is not dispersive or lossy, we have

$$\begin{aligned} \int dV \mathbf{H} \cdot \frac{\partial \mathbf{B}}{\partial t} &= \mu \int dV \mathbf{H} \cdot \frac{\partial \mathbf{H}}{\partial t} \\ &= \frac{\partial}{\partial t} \int dV \mu |\mathbf{H}|^2. \end{aligned} \quad (5.7)$$

The units of $[\mu|\mathbf{H}|^2]$ are W, so one can defined a magnetic energy density $\mu|\mathbf{H}|^2$, and

$$W_m = \int dV \mu |\mathbf{H}|^2, \quad (5.8)$$

for

$$\int dV \mathbf{H} \cdot \frac{\partial \mathbf{B}}{\partial t} = \frac{\partial W_m}{\partial t}. \quad (5.9)$$

This is the rate of change of stored magnetic energy [J/s = W].

Similarly

$$\begin{aligned} \int dV \mathbf{E} \cdot \frac{\partial \mathbf{D}}{\partial t} &= \epsilon \int dV \mathbf{E} \cdot \frac{\partial \mathbf{E}}{\partial t} \\ &= \frac{\partial}{\partial t} \int dV \epsilon |\mathbf{E}|^2. \end{aligned} \quad (5.10)$$

The electric energy density is $\epsilon|\mathbf{E}|^2$. Let

$$W_e = \int dV \epsilon |\mathbf{E}|^2, \quad (5.11)$$

and

$$\int dV \mathbf{E} \cdot \frac{\partial \mathbf{D}}{\partial t} = \frac{\partial W_e}{\partial t}. \quad (5.12)$$

We also have a term

$$\begin{aligned} \int dV \mathbf{E} \cdot \mathbf{J}_c &= \int dV \mathbf{E} \cdot (\sigma \mathbf{E}) \\ &= \int dV \sigma |\mathbf{E}|^2 \end{aligned} \quad (5.13)$$

This is the rate of change of stored electric energy.

The remaining term is

$$\oint d\mathbf{a} \cdot (\mathbf{E} \times \mathbf{H}) \quad (5.14)$$

This is a density of the power that is leaving the volume. The vector $\mathbf{E} \times \mathbf{H}$ is special, called the Poynting vector, and coincidentally points in the direction that the energy leaves the bounding surface per unit time. We write

$$\mathbf{S} = \mathbf{E} \times \mathbf{H}. \quad (5.15)$$

In vacuum the phase velocity \mathbf{v}_p , group velocity \mathbf{v}_g and packet(?) velocity \mathbf{v}_p all line up. This isn't the case in the media.

It turns out that without dissipation

$$\int \mathbf{H} \cdot \frac{\partial \mathbf{B}}{\partial t} = \int \mathbf{E} \cdot \frac{\partial \mathbf{D}}{\partial t}. \quad (5.16)$$

For example in an LC circuit fig. 5.1 half the cycle the energy is stored in the inductor, and in the other half of the cycle the energy is stored in the capacitor.

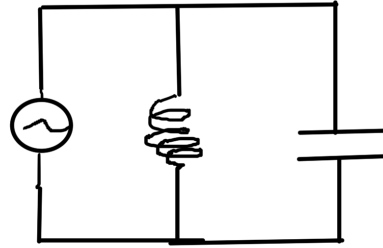

Figure 5.1: LC circuit.

Summarizing

$$\oint (\mathbf{E} \times \mathbf{H}) \cdot d\mathbf{a} = P_{\text{exit}}. \quad (5.17)$$

Time harmonics Recall that we have differential equations to solve for each type of circuit element in the time domain. For example in fig. 5.2, we have

$$V_i(t) = L \frac{di}{dt}, \quad (5.18)$$

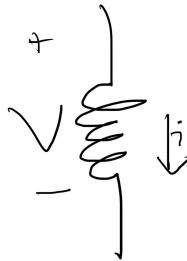

Figure 5.2: Inductor.

and for the capacitor sketched in fig. 5.3, we have

$$i_c(t) = C \frac{dV_c}{dt}. \quad (5.19)$$

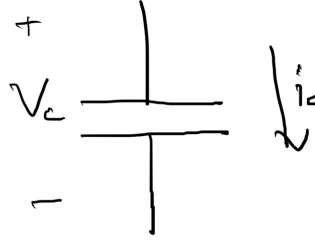

Figure 5.3: Capacitor.

When we use Laplace or Fourier techniques to solve circuits with such differential equation elements. The price that we paid for that was that we have to start dealing with complex-valued (phasor) quantities. We can do this for field equations as well. The goal is to remove the time domain coupling in Maxwell equations like

$$\nabla \times \mathbf{E}(\mathbf{r}, t) = -\frac{\partial \mathbf{B}}{\partial t}(\mathbf{r}, t) \quad (5.20)$$

$$\nabla \times \mathbf{H}(\mathbf{r}, t) = \sigma \mathbf{E} + \frac{\partial \mathbf{D}}{\partial t}(\mathbf{r}, t). \quad (5.21)$$

For a single frequency, assume that the time dependency can be written as

$$\mathbf{E}(\mathbf{r}, t) = \text{Re}(\mathbf{E}^*(\mathbf{r})e^{j\omega t}). \quad (5.22)$$

We may now have to require $\mathbf{E}(\mathbf{r})$ to be complex valued. We also have to be really careful about which convention of the time domain solution we are going to use, since we could just as easily use

$$\mathbf{E}(\mathbf{r}, t) = \text{Re}(\mathbf{E}(\mathbf{r})e^{-j\omega t}). \quad (5.23)$$

For example

$$\text{Re}(e^{ikz}e^{-i\omega t}) = \cos(kz - \omega t), \quad (5.24)$$

is identical with

$$\text{Re}(e^{-jkz}e^{j\omega t}) = \cos(\omega t - kz), \quad (5.25)$$

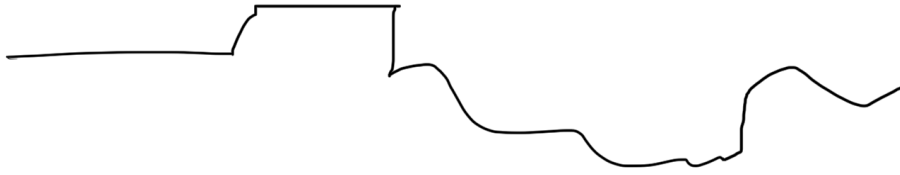

Figure 5.4: Non-sinusoidal time dependence.

showing that a solution or its complex conjugate is equally valid.

Engineering books use $e^{j\omega t}$ whereas most physicists use $e^{-i\omega t}$.

What if we have more complex time dependencies, such as that sketched in fig. 5.4?

We can do this using Fourier superposition, adding a finite or infinite set of single frequency solutions. The first order of business is to solve the system for a single frequency.

Let's write our Fourier transform pairs as

$$\mathcal{F}(\mathbf{A}(\mathbf{r}, t)) = \mathbf{A}(\mathbf{r}, \omega) = \int_{-\infty}^{\infty} \mathbf{A}(\mathbf{r}, t) e^{-j\omega t} dt \quad (5.26a)$$

$$\mathbf{A}(\mathbf{r}, t) = \mathcal{F}^{-1}(\mathbf{A}(\mathbf{r}, \omega)) = \frac{1}{2\pi} \int_{-\infty}^{\infty} \mathbf{A}(\mathbf{r}, \omega) e^{j\omega t} d\omega. \quad (5.26b)$$

In particular

$$\mathcal{F}\left(\frac{df(t)}{dt}\right) = j\omega F(\omega), \quad (5.27)$$

so the Fourier transform of the Maxwell equation

$$\mathcal{F}(\nabla \times \mathbf{E}(\mathbf{r}, t)) = \mathcal{F}\left(-\frac{\partial \mathbf{B}}{\partial t}(\mathbf{r}, t)\right), \quad (5.28)$$

is

$$\nabla \times \mathbf{E}(\mathbf{r}, \omega) = -j\omega \mathbf{B}(\mathbf{r}, \omega). \quad (5.29)$$

The four Maxwell's equations can be written as

- Faraday's Law

$$\nabla \times \mathbf{E}(\mathbf{r}, \omega) = -j\omega \mathbf{B}(\mathbf{r}, \omega) - \mathbf{M}_i \quad (5.30)$$

- Ampere-Maxwell equation

$$\nabla \times \mathbf{H}(\mathbf{r}, \omega) = \mathbf{J}_c(\mathbf{r}, \omega) + \mathbf{D}(\mathbf{r}, \omega) \quad (5.31)$$

- Gauss's law

$$\nabla \cdot \mathbf{D}(\mathbf{r}, \omega) = \rho_{ev}(\mathbf{r}, \omega) \quad (5.32)$$

- Gauss's law for magnetism

$$\nabla \cdot \mathbf{B}(\mathbf{r}, \omega) = \rho_{mv}(\mathbf{r}, \omega). \quad (5.33)$$

Now we can more easily model non-simple media with

$$\begin{aligned} \mathbf{B}(\mathbf{r}, \omega) &= \mu(\omega)\mathbf{H}(\mathbf{r}, \omega) \\ \mathbf{D}(\mathbf{r}, \omega) &= \epsilon(\omega)\mathbf{E}(\mathbf{r}, \omega). \end{aligned} \quad (5.34)$$

so Maxwell's equations are

$$\nabla \times \mathbf{E}(\mathbf{r}, \omega) = -j\omega\mu(\omega)\mathbf{H}(\mathbf{r}, \omega) - \mathbf{M}_i \quad (5.35)$$

$$\nabla \times \mathbf{H}(\mathbf{r}, \omega) = \mathbf{J}_c(\mathbf{r}, \omega) + \epsilon(\omega)\mathbf{E}(\mathbf{r}, \omega) \quad (5.36)$$

$$\epsilon(\omega)\nabla \cdot \mathbf{E}(\mathbf{r}, \omega) = \rho_{ev}(\mathbf{r}, \omega) \quad (5.37)$$

$$\mu(\omega)\nabla \cdot \mathbf{H}(\mathbf{r}, \omega) = \rho_{mv}(\mathbf{r}, \omega). \quad (5.38)$$

Frequency domain Poynting The frequency domain (time harmonic) equivalent of the instantaneous Poynting theorem is

$$\frac{1}{2} \oint d\mathbf{a} \cdot (\mathbf{E} \times \mathbf{H}^*) - \frac{1}{2} \int dV (\mathbf{H}^* \cdot \mathbf{M}_i + \mathbf{E} \cdot \mathbf{J}_i^*) + \frac{1}{2} \int dV \sigma |\mathbf{E}|^2 + j\omega \frac{1}{2} \int dV (\mu |\mathbf{H}|^2 - \epsilon |\mathbf{E}|^2) = 0. \quad (5.39)$$

Showing this is left as an exersize. Since

$$\text{Re}(\mathbf{A}) \times \text{Re}(\mathbf{B}) \neq \text{Re}(\mathbf{A} \times \mathbf{B}). \quad (5.40)$$

We want to find the instantaneous Poynting vector in terms of the phasor fields. Following [2], where script is used for the instantaneous quantities and non-script for the phasors, we find

$$\begin{aligned}
\mathcal{S}(\mathbf{r}, t) &= \mathcal{E}(\mathbf{r}, t) \times \mathcal{H}(\mathbf{r}, t) \\
&= \operatorname{Re}(\mathcal{E}(\mathbf{r}, t)) \times \operatorname{Re}(\mathcal{H}(\mathbf{r}, t)) \\
&= \frac{\mathbf{E}e^{j\omega t} + \mathbf{E}^*e^{-j\omega t}}{2} \times \frac{\mathbf{H}e^{j\omega t} + \mathbf{H}^*e^{-j\omega t}}{2} \\
&= \frac{1}{4} (\mathbf{E} \times \mathbf{H}^* + \mathbf{E}^* \times \mathbf{H} + \mathbf{E} \times \mathbf{H}e^{2j\omega t} + \mathbf{H} \times \mathbf{E}e^{-2j\omega t}) \\
&= \frac{1}{2} \operatorname{Re}(\mathbf{E} \times \mathbf{H}^*) + \frac{1}{2} \operatorname{Re}(\mathbf{E} \times \mathbf{H}e^{2j\omega t}).
\end{aligned} \tag{5.41}$$

Should we time average over a period $\langle \cdot \rangle = (1/T) \int_0^T (\cdot)$ the second term is killed, so that

$$\langle \mathcal{S} \rangle = \frac{1}{2} \operatorname{Re}(\mathbf{E} \times \mathbf{H}^*) + \frac{1}{2} \operatorname{Re}(\mathbf{E} \times \mathbf{H}e^{2j\omega t}). \tag{5.42}$$

The instantaneous Poynting vector is thus

$$\mathcal{S}(\mathbf{r}, t) = \langle \mathbf{S} \rangle + \frac{1}{2} \operatorname{Re}(\mathbf{E} \times \mathbf{H}e^{j\omega t}). \tag{5.43}$$

5.1 PROBLEMS

Exercise 5.1 Index of refraction.

Transmitter T of a time-harmonic wave of frequency ν moves with velocity \mathbf{U} at an angle θ relative to the direct line to a stationary receiver R , as sketched in fig. 5.5.

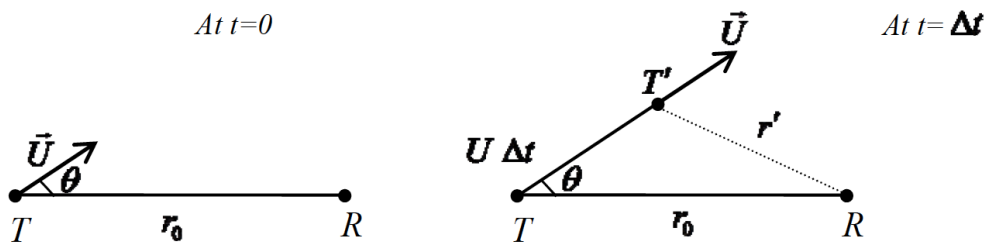

Figure 5.5: Field refraction.

- Derive the expression for the frequency detected by the receiver R , assuming that the medium between T and R has a positive index of refraction n . (Apply the appropriate approximations.)

- b. How is the expression obtained in part a is modified if the medium is a metamaterial with negative index of refraction.
- c. From the physical point of view, how is the situation in part b different from part a ?

Answer for Exercise 5.1

PROBLEM SET RELATED MATERIAL REDACTED IN THIS DOCUMENT.PLEASE FEEL FREE TO EMAIL ME FOR THE FULL VERSION IF YOU AREN'T TAKING ECE1228.

[REDACTED]

END-REDACTION

Exercise 5.2 Phasor equality.

Prove that if

$$\text{Re}(\mathbf{A}(\mathbf{r})e^{j\omega t}) = \text{Re}(\mathbf{B}(\mathbf{r})e^{j\omega t}), \tag{5.44}$$

then $\mathbf{A}(\mathbf{r}) = \mathbf{B}(\mathbf{r})$. This means that the $\text{Re}()$ operator can be removed on phasors of the same frequency.

Answer for Exercise 5.2

PROBLEM SET RELATED MATERIAL REDACTED IN THIS DOCUMENT.PLEASE FEEL FREE TO EMAIL ME FOR THE FULL VERSION IF YOU AREN'T TAKING ECE1228.

[REDACTED]

END-REDACTION

Exercise 5.3 Duality theorem.

Prove that if the time-harmonic fields $\mathbf{E}(\mathbf{r})$ and $\mathbf{H}(\mathbf{r})$ are solutions to Maxwell's equations in a simple, source free medium ($\mathbf{M}_i = \mathbf{J}_i = \mathbf{J}_c = 0, \rho_{mv} = \rho_{ev} = 0$), characterized by ϵ, μ ; then

$\mathbf{E}'(\mathbf{r}) = \eta\mathbf{H}(\mathbf{r})$ and $\mathbf{H}'(\mathbf{r}) = -\frac{\mathbf{E}(\mathbf{r})}{\eta}$ are also solutions of the Maxwell equations. η is the intrinsic impedance of the medium.

Remark : By showing the above you have proved the validity of the so called duality theorem.

Answer for Exercise 5.3

PROBLEM SET RELATED MATERIAL REDACTED IN THIS DOCUMENT.PLEASE FEEL FREE TO EMAIL ME FOR THE FULL VERSION IF YOU AREN'T TAKING ECE1228.

[REDACTED]

END-REDACTION

Exercise 5.4 Poynting theorem

Using Maxwell's equations given in the class notes, derive the Poynting theorem in both differential and integral form for instantaneous fields. Assume a linear, homogeneous medium with no temporal dispersion.

Answer for Exercise 5.4

PROBLEM SET RELATED MATERIAL REDACTED IN THIS DOCUMENT.PLEASE FEEL FREE TO EMAIL ME FOR THE FULL VERSION IF YOU AREN'T TAKING ECE1228.

[REDACTED]

END-REDACTION

Exercise 5.5 Frequency domain time averaged Poynting theorem

The time domain Poynting relationship was found to be

$$0 = \nabla \cdot (\mathbf{E} \times \mathbf{H}) + \frac{\epsilon}{2} \mathbf{E} \cdot \frac{\partial \mathbf{E}}{\partial t} + \frac{\mu}{2} \mathbf{H} \cdot \frac{\partial \mathbf{H}}{\partial t} + \mathbf{H} \cdot \mathbf{M}_i + \mathbf{E} \cdot \mathbf{J}_i + \sigma \mathbf{E} \cdot \mathbf{E}. \quad (5.45)$$

Derive the equivalent relationship for the time averaged portion of the time-harmonic Poynting vector.

Answer for Exercise 5.5

PROBLEM SET RELATED MATERIAL REDACTED IN THIS DOCUMENT.PLEASE FEEL FREE TO EMAIL ME FOR THE FULL VERSION IF YOU AREN'T TAKING ECE1228.

[REDACTED]

END-REDACTION

Lorentz-Lorenz Dispersion We will model the medium using a frequency representation of the permittivity

$$\begin{aligned} \epsilon(\omega) &= \epsilon'(\omega) - j\epsilon''(\omega) \\ \mu(\omega) &= \mu'(\omega) - j\mu''(\omega) \end{aligned} \tag{5.46}$$

The real part is the phase, whereas the imaginary part is the loss.

$$\begin{aligned} n &= \frac{c}{v} \\ &= \frac{\sqrt{\epsilon\mu}}{\sqrt{\epsilon_0\mu_0}} \\ &= \sqrt{\epsilon_r\mu_r} \end{aligned} \tag{5.47}$$

We can also write

$$n(\omega) = n'(\omega) - jn''(\omega) \tag{5.48}$$

If we are considering an electric dipole

$$\mathbf{P}_i = Q_i \mathbf{x}_i \tag{5.49}$$

With

$$\mathbf{P} = \epsilon_0 \chi_e \mathbf{E}, \tag{5.50}$$

and a time harmonic representation for the electric field

$$\mathbf{E} = \mathbf{E}_0 e^{j\omega t}. \tag{5.51}$$

The dipole moment is assumed to be

$$\begin{aligned}
 \mathbf{P} &= \lim_{\Delta v \rightarrow 0} \frac{\sum_{i=1}^{N\Delta v} \mathbf{P}_i}{\Delta v} \\
 &= \frac{N\Delta v \mathbf{p}}{\Delta v} \\
 &= N\mathbf{p} \\
 &= NQ\mathbf{x}.
 \end{aligned} \tag{5.52}$$

We model the oscillating electron and nucleus as a mass and spring. This electron oscillator model is often called the Lorentz model. It is not really a model for atoms as such, but the way that an atom responds to perturbation. At the time when Lorentz formulated the model it was not known that the nuclei have massive mass as compared to the electrons. The Lorentz assumption was that in the absence of applied electric fields the centroids of positive and negative charges coincide, but when a field is applied, the electrons will experience a Lorentz force and will be displaced from their equilibrium position. He wrote “the displacement immediately gives rise to a new force by which the particle is pulled back towards its original position, and which we may therefore appropriately distinguish by the name of elastic force.”

The forces of interest are

$$\begin{aligned}
 F_{\text{friction}} &= -D \frac{dx}{dt} = -Dv \\
 F_{\text{elastic}} &= -Sx \\
 F_{\text{external}} &= QE = QE_0 e^{j\omega t}
 \end{aligned} \tag{5.53}$$

Adding all the forces, the electrical system, in one dimension, can be assumed to have the form

$$F = m \frac{d^2 x}{dt^2} = -D \frac{dx}{dt} - Dv - Sx + QE_0 e^{j\omega t}, \tag{5.54}$$

or

$$\frac{d^2 x}{dt^2} + \frac{D}{m} \frac{dx}{dt} + \frac{S}{m} x = \frac{QE_0}{m} e^{j\omega t} \tag{5.55}$$

Let's define

$$\begin{aligned}
 \gamma &= \frac{D}{m} \\
 \omega_0^2 &= \frac{S}{m},
 \end{aligned} \tag{5.56}$$

so that

$$\frac{d^2 x}{dt^2} + \gamma \frac{dx}{dt} + \omega_0^2 x = \frac{QE_0}{m} e^{j\omega t}. \tag{5.57}$$

Calculating the permittivity and susceptibility With $x = x_0 e^{j\omega t}$ we have

$$x_0(-\omega^2 + j\gamma\omega + \omega_0^2) = \frac{QE_0}{m}, \quad (5.58)$$

or (with $E = E_0 e^{j\omega t}$), just

$$x = x_0 e^{j\omega t} = \frac{QE}{m(-\omega^2 + j\gamma\omega + \omega_0^2)}. \quad (5.59)$$

I Assume that dipoles are identical

II Assume no coupling between dipoles

III There are N dipoles per unit volume. In other words, N is the number of dipoles per unit volume.

The polarization $P(t)$ is given by

$$P(t) = NQx, \quad (5.60)$$

where Q is the charge associate with the unit dipole. This has dimensions of $[\frac{1}{m^3} \times C \times m]$, or $[C/m^2]$. This polarization is

$$P(t) = \frac{Q^2 NE/m}{\omega_0^2 - \omega^2 + j\gamma\omega}. \quad (5.61)$$

In particular, the ratio of the polarization to the electric field magnitude is

$$\frac{P}{E} = \frac{Q^2 N/m}{\omega_0^2 - \omega^2 + j\gamma\omega}. \quad (5.62)$$

With $P = \epsilon_0 \chi_e E$, we have

$$\chi_e = \frac{Q^2 N/m\epsilon_0}{\omega_0^2 - \omega^2 + j\gamma\omega}. \quad (5.63)$$

Define

$$\omega_p^2 = \frac{Q^2 N}{m\epsilon_0}, \quad (5.64)$$

which has dimensions $[1/s^2]$. Then

$$\chi_e = \frac{\omega_p^2}{\omega_0^2 - \omega^2 + j\gamma\omega}. \quad (5.65)$$

With $\epsilon_r = 1 + \chi_e$ we have

$$\epsilon_r = \frac{\epsilon}{\epsilon_0} = 1 + \frac{\omega_p^2}{\omega_0^2 - \omega^2 + j\gamma\omega}. \quad (5.66)$$

One can show that $\epsilon_r = \epsilon'_r - j\epsilon''_r$ are given by

$$\epsilon'_r = \frac{\omega_p^2(\omega_0^2 - \omega^2)}{(\omega_0^2 - \omega^2)^2 + (\omega\gamma)^2} + 1, \quad (5.67)$$

$$\epsilon''_r = \frac{\omega_p^2\omega\gamma}{(\omega_0^2 - \omega^2)^2 + (\omega\gamma)^2}. \quad (5.68)$$

FIXME: calculate this.

No damping With $D = 0$, or $\gamma = 0$ then $\epsilon''_r = 0$,

$$x = \frac{QE_0/m}{\omega^2 - \omega_0^2} e^{j\omega t}, \quad (5.69)$$

and

$$\epsilon_r = \epsilon'_r = \frac{\epsilon}{\epsilon_0} = 1 + \frac{\omega_p^2}{\omega_0^2 - \omega^2}. \quad (5.70)$$

This has a curve like fig. 5.6.

instead of the normal damped resonance curve like fig. 5.7.

As $\omega \rightarrow \omega_0$, then the displacement $x \rightarrow \infty$. The frequency ω_0 is called the resonance frequency of the system.

If the resonance frequency is zero (free charges), then

$$\begin{aligned} \epsilon_r &= \epsilon'_r \\ &= 1 - \frac{\omega_p^2}{\omega^2}, \end{aligned} \quad (5.71)$$

which is negative for $\omega_p > \omega$.

When damping is present, the resonance frequency is the root of the characteristic equation of the homogeneous part of eq. (5.55).

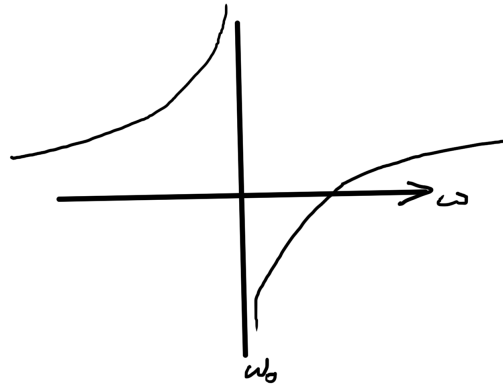

Figure 5.6: Undamped resonance.

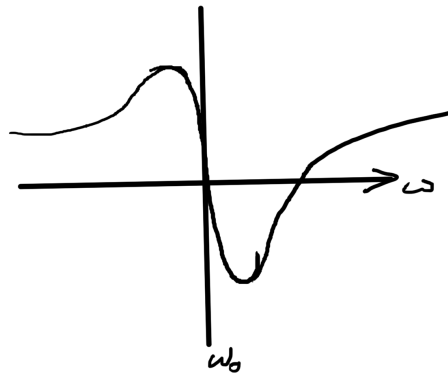

Figure 5.7: Damped resonance.

Exercise 5.7 Medium with multiple resonances.

Relative permittivity for a medium with multiple resonances is given by:

$$\epsilon_r = 1 + \chi_e = 1 + \sum_{k=1} \frac{\omega_{p,k}}{\omega_{0,k}^2 - \omega^2 + j\gamma_k\omega} \tag{5.74}$$

Moreover, the case of an *active medium* (i.e. medium with gain) can be modeled by allowing $\omega_{p,k}$ in above to become purely imaginary. Under these conditions, plot

$$\text{Re}(n(\omega)) - 1, \tag{5.75}$$

and

$$\text{Im}(n(\omega)) \tag{5.76}$$

as a function of detuning frequency,

$$\nu = \frac{\omega - \omega_c}{2\pi}, \tag{5.77}$$

for ammonia vapor (an active medium) where

$$\begin{aligned} \omega_{0,1} &= 2.4165825 \times 10^{15} \text{rad/s} \\ \omega_{0,2} &= 2.4166175 \times 10^{15} \text{rad/s} \\ \omega_{p,k} = \omega_p &= 10^{10} \text{rad/s} \\ \gamma_k = \gamma &= 5 \times 10^9 \text{rad/s} \\ (\omega - \omega_c)/2\pi &\in [-7, 7] \text{GHz} \\ \omega_c &= 2.4166 \times 10^{15} \text{rad/s} \end{aligned} \tag{5.78}$$

Answer for Exercise 5.7

PROBLEM SET RELATED MATERIAL REDACTED IN THIS DOCUMENT. PLEASE FEEL FREE TO EMAIL ME FOR THE FULL VERSION IF YOU AREN'T TAKING ECE1228.

[REDACTED]

END-REDACTION

6

DRUID MODEL

Disclaimer. These notes are mostly a direct transcription of Prof. M. Mojahedi's handwritten notes on this topic, mostly skipped over in class. These become relevant because this is used in the non-vacuum model of Maxwell's equations.

A nice vector based derivation of these Druid model results can be found in [1]. The Meissner effect is also discussed in that context.

Druid model In this section we will investigate the optical properties of free electrons, or what is commonly called free electron gas.

By free electron gas we mean electrons that do not experience the restoring force which we considered for bound charges in the case of Lorentz model. In particular, the resonance frequency ω_0 for free electrons is zero.

There are two typical cases of free electron systems

- a Metals.
- b Doped (n or p type) semiconductors.

For the moment we consider the case of metals.

Free electrons are responsible for high reflectivity and good thermal conductivity of metals up to optical frequencies. A model that can be used to describe the high reflectivity of metals is the Drude model.

Plasma: A neutral gas of free electrons and heavy ions is called plasma. Examples of plasma are metals and doped semiconductors, since these materials are a combination of free electrons and heavy ions which are, in sum, electrically neutral.

Drude-Lorentz model , (or Drude model for short): similar to the case of bound charges we already studied for free electron plasma, we can start with a harmonic oscillator model. However, in this case, since electrons are free, there is no restoring force (i.e. $\omega_0 = 0$). Recall that in the spring mass model $\omega_0^2 = S/m$ where S was the spring tension coefficient.

With such a model the Lorentz model equation

$$\frac{d^2x}{dt^2} + \gamma \frac{dx}{dt} + \omega_0^2 x = \frac{QE_0}{m} e^{j\omega t}, \quad (6.1)$$

is reduced to

$$\frac{d^2x}{dt^2} + \gamma \frac{dx}{dt} = \frac{QE_0}{m} e^{j\omega t}, \quad (6.2)$$

Again, assuming a solution of the form $x_p = x_0 e^{j\omega t}$ for the particular solution and substituting in eq. (6.2), we have

$$x_0 \left((j\omega)^2 + \gamma(j\omega) \right) = \frac{QE_0}{m}, \quad (6.3)$$

or

$$x = \frac{QE/m}{-\omega^2 + j\gamma\omega}, \quad (6.4)$$

Once more assuming identical particles that are not coupled and a linear isotropic medium and using the fact that $\mathbf{P} = N\mathbf{p} = NQ\mathbf{x}$, and

$$\chi_e = \frac{|\mathbf{P}|}{\epsilon_0 |\mathbf{E}|}, \quad (6.5)$$

we have

$$\chi_e = \frac{Q^2 N / m \epsilon_0}{-\omega^2 + j\gamma\omega}, \quad (6.6)$$

or with $\omega_p^2 = Q^2 N / m \epsilon_0$,

$$\begin{aligned} \epsilon_r &= 1 + \chi_e \\ &= 1 + \frac{\omega_p^2}{-\omega^2 + j\gamma\omega}. \end{aligned} \quad (6.7)$$

Plasma frequency, ω_p , can be understood as the natural resonance frequency by which the free electron gas (plasma) collectively (not individual electrons) oscillates.

Note that if we neglect the last term, i.e., let $\gamma = 0$ then

$$\epsilon_r = 1 - \frac{\omega_p^2}{\omega^2}. \quad (6.8)$$

From this it is clear that when $\omega < \omega_p$, we have $\epsilon_r < 1$ and $n = \sqrt{\epsilon_r}$ is purely imaginary, and the wave attenuates inside the electron plasma.

This means that for $\omega < \omega_p$ electromagnetic waves do not propagate a large distance inside of metal. However, for $\omega > \omega_p$ the electron plasma (e.g. metal) is transparent. The latter is called ultraviolet transparency of metal, because for most metals ω_p is in the ultraviolet part of the spectrum. For example,

- For Al

$$\begin{aligned} \frac{\omega_p}{2\pi} &= 3.82 \times 10^{15} \text{ Hz} \\ \Rightarrow \lambda_p & \\ &= 79[\text{nm}], \end{aligned} \tag{6.9}$$

- For Au

$$\begin{aligned} \frac{\omega_p}{2\pi} &= 5.9 \times 10^{15} \text{ Hz} \\ \Rightarrow \lambda_p & \\ &= 138[\text{nm}], \end{aligned} \tag{6.10}$$

Using eq. (6.8) one can calculate

$$\tilde{n} = \sqrt{\epsilon_r}, \tag{6.11}$$

and plot the reflectivity R at normal incidence

$$R = \left| \frac{\tilde{n} - 1}{\tilde{n} + 1} \right|^2, \tag{6.12}$$

which will have a shape similar to that of fig. 6.1.

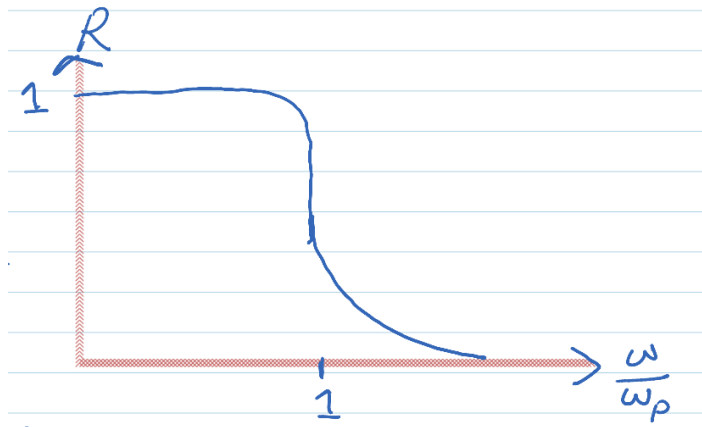

Figure 6.1: Metal reflectivity.

This figure shows that for $\omega/\omega_p \ll 1$ metal reflects most of the incident light, whereas it becomes transparent (it transmits light) for $\omega/\omega_p \gg 1$. This explains the shiny appearance of the metal at optical wavelengths.

The fact that plasma reflects EM waves below a ω_p frequency can be used to transmit AM radio waves. The ionosphere can be viewed as a plasma gas due to free electrons generated by cosmic radiation and ultraviolet light from the sun. The ω_p for ionosphere plasma is $\omega_p = O(1\text{MHz})$. Therefore AM signals modulated at frequencies below or in the range of a MHz will be reflected from the ionosphere. But FM signals where the modulation frequency is greater than MHz will not be reflected, but will travel through the ionosphere and into space.

Conductivity

$$\begin{aligned}\nabla \times \mathbf{H}(\mathbf{r}, \omega) &= \sigma \mathbf{E}(\mathbf{r}, \omega) + j\omega\epsilon_0 \mathbf{E}(\mathbf{r}, \omega) \\ &= j\omega\epsilon_0 \left(1 + \frac{\sigma}{j\omega\epsilon_0}\right) \mathbf{E}(\mathbf{r}, \omega) \\ &= j\omega\epsilon_0 \left(1 - \frac{j\sigma}{\omega\epsilon_0}\right) \mathbf{E}(\mathbf{r}, \omega)\end{aligned}\tag{6.13}$$

This complex factor is the relative permittivity

$$\epsilon_r = 1 - \frac{j\sigma}{\omega\epsilon_0},\tag{6.14}$$

and is why we write

$$\epsilon(\omega) = \epsilon'(\omega) - j\epsilon''(\omega)\tag{6.15}$$

6.1 PROBLEMS

7

WAVE EQUATION

Wave equation Using an expansion of the triple cross product in terms of the Laplacian

$$\begin{aligned}\nabla \times (\nabla \times \mathbf{f}) &= -\nabla \cdot (\nabla \wedge \mathbf{f}) \\ &= -\nabla^2 \mathbf{f} + \nabla (\nabla \cdot \mathbf{f}),\end{aligned}\tag{7.1}$$

we can evaluate the cross products

$$\begin{aligned}\nabla \times (\nabla \times \mathcal{E}) &= \nabla \times \left(-\frac{\partial \mathcal{B}}{\partial t} - \mathbf{m} \right) \\ \nabla \times (\nabla \times \mathcal{H}) &= \nabla \times \left(\frac{\partial \mathcal{D}}{\partial t} + \mathcal{G} \right),\end{aligned}\tag{7.2}$$

or

$$\begin{aligned}-\nabla^2 \mathcal{E} + \nabla (\nabla \cdot \mathcal{E}) &= -\mu \frac{\partial}{\partial t} \nabla \times \mathcal{H} - \nabla \times \mathbf{m} \\ -\nabla^2 \mathcal{H} + \nabla (\nabla \cdot \mathcal{H}) &= \epsilon \frac{\partial}{\partial t} (\nabla \times \mathcal{E}) + \nabla \times \mathcal{G},\end{aligned}\tag{7.3}$$

or

$$\begin{aligned}-\nabla^2 \mathcal{E} + \frac{1}{\epsilon} \nabla \rho_{ev} &= -\mu \frac{\partial}{\partial t} \left(\frac{\partial \mathcal{D}}{\partial t} + \mathcal{G} \right) - \nabla \times \mathbf{m} \\ -\nabla^2 \mathcal{H} + \frac{1}{\mu} \nabla \rho_{mv} &= \epsilon \frac{\partial}{\partial t} \left(-\frac{\partial \mathcal{B}}{\partial t} - \mathbf{m} \right) + \nabla \times \mathcal{G},\end{aligned}\tag{7.4}$$

This decouples the equations for the electric and the magnetic fields

$$\begin{aligned}\nabla^2 \mathcal{E} &= \mu \epsilon \frac{\partial^2 \mathcal{E}}{\partial t^2} + \frac{1}{\epsilon} \nabla \rho_{ev} + \mu \frac{\partial \mathcal{G}}{\partial t} + \nabla \times \mathbf{m} \\ \nabla^2 \mathcal{H} &= \epsilon \mu \frac{\partial^2 \mathcal{H}}{\partial t^2} + \frac{1}{\mu} \nabla \rho_{mv} + \epsilon \frac{\partial \mathbf{m}}{\partial t} - \nabla \times \mathcal{G},\end{aligned}\tag{7.5}$$

Splitting the current between induced and bound (?) currents

$$\mathcal{G} = \mathcal{G}_i + \mathcal{G}_c = \mathcal{G}_i + \sigma \mathcal{E},\tag{7.6}$$

these become

$$\begin{aligned}\nabla^2 \mathcal{E} &= \mu \epsilon \frac{\partial^2 \mathcal{E}}{\partial t^2} + \frac{1}{\epsilon} \nabla \rho_{ev} + \mu \sigma \frac{\partial \mathcal{E}}{\partial t} + \nabla \times \mathbf{m} + \mu \frac{\partial \mathcal{G}_i}{\partial t} \\ \nabla^2 \mathcal{H} &= \epsilon \mu \frac{\partial^2 \mathcal{H}}{\partial t^2} + \frac{1}{\mu} \nabla \rho_{mv} + \epsilon \frac{\partial \mathbf{m}}{\partial t} + \sigma \mu \frac{\partial \mathcal{H}}{\partial t} + \sigma \mathbf{m} - \nabla \times \mathcal{G}_i.\end{aligned}\tag{7.7}$$

Time harmonic form Assuming time harmonic dependence $\mathcal{X} = \mathbf{X}e^{j\omega t}$, we find

$$\begin{aligned}\nabla^2 \mathbf{E} &= (-\omega^2 \mu \epsilon + j\omega \mu \sigma) \mathbf{E} + \frac{1}{\epsilon} \nabla \rho_{ev} + \nabla \times \mathbf{M} + j\omega \mu \mathbf{J}_i \\ \nabla^2 \mathbf{H} &= (-\omega^2 \epsilon \mu + j\omega \sigma \mu) \mathbf{H} + \frac{1}{\mu} \nabla \rho_{mv} + (j\omega \epsilon + \sigma) \mathbf{M} - \nabla \times \mathbf{J}_i.\end{aligned}\tag{7.8}$$

For a lossy medium where $\epsilon = \epsilon' - j\omega \epsilon''$, the leading term factor is

$$-\omega^2 \mu \epsilon + j\omega \mu \sigma = -\omega^2 \mu \epsilon' + j\omega \mu (\sigma + \omega \epsilon'').\tag{7.9}$$

With the definition

$$\gamma^2 = (\alpha + j\beta)^2 = -\omega^2 \mu \epsilon' + j\omega \mu (\sigma + \omega \epsilon''),\tag{7.10}$$

the wave equations have the form

$$\begin{aligned}\nabla^2 \mathbf{E} &= \gamma^2 \mathbf{E} + \frac{1}{\epsilon} \nabla \rho_{ev} + \nabla \times \mathbf{M} + j\omega \mu \mathbf{J}_i \\ \nabla^2 \mathbf{H} &= \gamma^2 \mathbf{H} + \frac{1}{\mu} \nabla \rho_{mv} + (j\omega \epsilon + \sigma) \mathbf{M} - \nabla \times \mathbf{J}_i.\end{aligned}\tag{7.11}$$

Here

- α is the attenuation constant [Np/m]
- β is the phase velocity [rad/m]
- γ is the propagation constant [1/m]

We are usually interested in solutions in regions free of magnetic currents, induced electric currents, and free of any charge densities, in which case the wave equations are just

$$\begin{aligned}\nabla^2 \mathbf{E} &= \gamma^2 \mathbf{E} \\ \nabla^2 \mathbf{H} &= \gamma^2 \mathbf{H}.\end{aligned}\tag{7.12}$$

7.1 PROBLEMS

Exercise 7.1 Meissner effect.

The constitutive relation for superconductors in weak magnetic fields can be macroscopically characterized by the first London equation

$$\frac{\partial \mathbf{J}_{\text{sup}}}{\partial t} = \alpha \mathbf{E},\tag{7.13}$$

and the second London equation

$$\nabla \times \mathbf{J}_{\text{sup}} = -\alpha_1 \mathbf{B}, \quad (7.14)$$

where \mathbf{J}_{sup} stands for the superconducting current, $\alpha = n_s q^2 / m$ and $\alpha_1 \approx \alpha$, with n_s , m , and q denoting, respectively, the number density, the effective mass, and the charge of the Cooper pairs responsible for the superconductivity in a charged Boson fluid model.

- a. From the first London equation, derive an equation for $\dot{\mathbf{B}} = \partial \mathbf{B} / \partial t$ by using the static Maxwell equation $\nabla \times \mathbf{H} = \mathbf{J}_{\text{sup}}$ without the displacement current. Show that

$$\nabla^2 \dot{\mathbf{B}} = \mu_0 \alpha \dot{\mathbf{B}} \quad (7.15)$$

- b. From the second London equation and the Ampere's law stated above derive an equation for \mathbf{B} .
- c. What are the penetration depths in the part **a** and part **b** cases? Justify your answer.

Remark: from above analysis we see that both the current and magnetic field are confined to a thin layer of the order of the penetration depth which is very small. The exclusion of static magnetic field in a superconductor is known as the Meissner effect experimentally discovered in 1933.

Answer for Exercise 7.1

PROBLEM SET RELATED MATERIAL REDACTED IN THIS DOCUMENT.PLEASE
FEEL FREE TO EMAIL ME FOR THE FULL VERSION IF YOU AREN'T TAKING ECE1228.

[REDACTED]

END-REDACTION

WAVE EQUATION SOLUTIONS

In class, we walked through splitting up the wave equation into components, and separation of variables. I didn't take notes on that.

Winding down that discussion, however, was a mention of phase and group velocity, and a phenomena called superluminal velocity. This latter is analogous to quantum electron tunneling where a wave can make it through an aperture with a damped solution $e^{-\alpha x}$ in the aperture interval, and sinusoidal solutions in the incident and transmitted regions as sketched in fig. 8.1. The time τ to get through the aperture is called the tunnelling time.

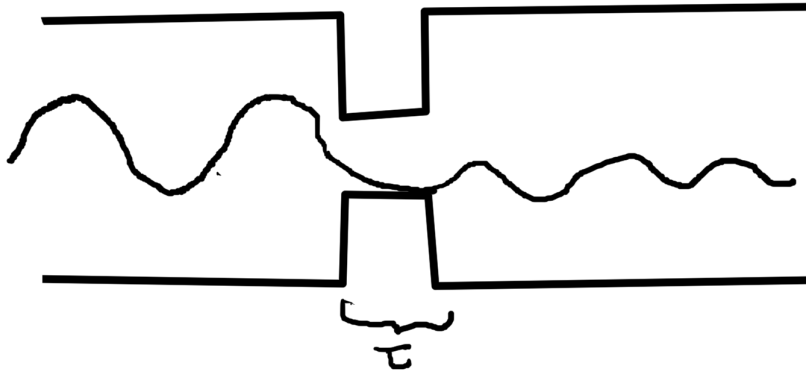

Figure 8.1: Superluminal tunneling.

8.1 PROBLEMS

Exercise 8.1 Lossy waves.

In the case of lossy medium the wave equation was given by

$$\nabla^2 \mathbf{E} = \gamma^2 \mathbf{E}, \quad (8.1)$$

where

$$\gamma^2 = (\alpha + j\beta)^2. \quad (8.2)$$

Now consider a medium for which $\epsilon(\omega) = \epsilon'(\omega)$ (i.e. $\epsilon''(\omega) = 0$), $\sigma = \sigma_0$ (i.e. $\omega\tau \sim 0$ in the Drude model), and μ is a constant and real. For this case obtain the expression for α and β in terms of $\omega, \mu, \epsilon', \sigma_0$.

Answer for Exercise 8.1

PROBLEM SET RELATED MATERIAL REDACTED IN THIS DOCUMENT.PLEASE FEEL FREE TO EMAIL ME FOR THE FULL VERSION IF YOU AREN'T TAKING ECE1228.

REDACTED

Exercise 8.2 Uniform plane wave.

Note: This seemed like a separate problem, and has been split out from the problem 2 as specified in the original problem set handout.

The uniform plane wave

$$\mathcal{E}(\mathbf{r}, t) = E_0 (\hat{\mathbf{x}} \cos \theta - \hat{\mathbf{z}} \sin \theta) \cos(\omega t - k \sin \theta x - k \cos \theta z) \tag{8.3}$$

is propagating in the $x - z$ plane as sketched in fig. 8.2 in a simple medium with $\sigma = 0$. Here,

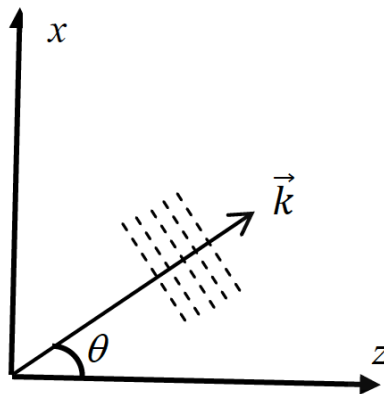

Figure 8.2: Linear wave front.

WAVE EQUATION SOLUTIONS

Cylindrical coordinates Seek a function

$$\mathbf{E} = E_\rho \hat{\rho} + E_\phi \hat{\phi} + E_z \hat{z} \quad (9.1)$$

solving

$$\nabla^2 \mathbf{E} = -\beta^2 \mathbf{E}. \quad (9.2)$$

One way to find the Laplacian in cylindrical coordinates is to use

$$\nabla^2 \mathbf{E} = \nabla (\nabla \cdot \mathbf{E}) - \nabla \times (\nabla \times \mathbf{E}), \quad (9.3)$$

where

$$\nabla = \hat{\rho} \frac{\partial}{\partial \rho} + \frac{\hat{\phi}}{\rho} \frac{\partial}{\partial \phi} + \hat{z} \frac{\partial}{\partial z}. \quad (9.4)$$

It can be shown that:

$$\nabla \cdot \mathbf{E} = \frac{1}{\rho} \frac{\partial}{\partial \rho} (\rho E_\rho) + \frac{1}{\rho} \frac{\partial E_\phi}{\partial \phi} + \frac{\partial E_z}{\partial z} \quad (9.5)$$

and

$$\nabla \times \mathbf{E} = \hat{\rho} \left(\frac{1}{\rho} \partial_\phi E_z - \partial_z E_\phi \right) + \hat{\phi} \left(\partial_z E_\rho - \partial_\rho E_z \right) + \hat{z} \left(\frac{1}{\rho} \partial_\rho (\rho E_\phi) - \frac{1}{\rho} \partial_\phi E_\rho \right) \quad (9.6)$$

This gives

$$\nabla^2 \psi = \frac{\partial^2 \psi}{\partial \rho^2} + \frac{1}{\rho} \frac{\partial \psi}{\partial \rho} + \frac{1}{\rho^2} \frac{\partial^2 \psi}{\partial \phi^2} + \frac{\partial^2 \psi}{\partial z^2}. \quad (9.7)$$

and

$$\begin{aligned} \nabla^2 E_\rho &= \left(-\frac{E_\rho}{\rho^2} - \frac{2}{\rho^2} \frac{\partial E_\phi}{\partial \phi} \right) \\ \nabla^2 E_\phi &= \left(-\frac{E_\phi}{\rho^2} + \frac{2}{\rho^2} \frac{\partial E_\rho}{\partial \phi} \right) \\ \nabla^2 E_z &= -\beta^2 E_z. \end{aligned} \quad (9.8)$$

This is explored in appendix F.

TEM: If we want to have a TEM mode it can be shown that we need an axial distribution mechanism, such as the core of a co-axial cable.

These are messy to solve in general, but we can solve the z-component without too much pain

$$\frac{\partial^2 E_z}{\partial \rho^2} + \frac{1}{\rho} \frac{\partial E_z}{\partial \rho} + \frac{1}{\rho^2} \frac{\partial^2 E_z}{\partial \phi^2} + \frac{\partial^2 E_z}{\partial z^2} = -\beta^2 E_z \quad (9.9)$$

Solving this using separation of variables with

$$E_z = R(\rho)P(\phi)Z(z) \quad (9.10)$$

$$\frac{1}{R} \left(R'' + \frac{1}{\rho} R' \right) + \frac{1}{\rho^2 P} P'' + \frac{Z''}{Z} = -\beta^2 \quad (9.11)$$

Assuming for some constant β_z that we have

$$\frac{Z''}{Z} = -\beta_z^2, \quad (9.12)$$

then

$$\frac{1}{R} (\rho^2 R'' + \rho R') + \frac{1}{P} P'' + \rho^2 (\beta^2 - \beta_z^2) = 0 \quad (9.13)$$

Now assume that

$$\frac{1}{P} P'' = -m^2, \quad (9.14)$$

and let $\beta^2 - \beta_z^2 = \beta_\rho^2$, which leaves

$$\rho^2 R'' + \rho R' + (\rho^2 \beta_\rho^2 - m^2) R = 0. \quad (9.15)$$

This is the Bessel differential equation, with travelling wave solution

$$R(\rho) = AH_m^{(1)}(\beta_\rho \rho) + BH_m^{(2)}(\beta_\rho \rho), \quad (9.16)$$

and standing wave solutions

$$R(\rho) = AJ_m(\beta_\rho \rho) + BY_m(\beta_\rho \rho). \quad (9.17)$$

Here $H_m^{(1)}, H_m^{(2)}$ are Hankel functions of the first and second kinds, and J_m, Y_m are the Bessel functions of the first and second kinds.

For $P(\phi)$

$$P'' = -m^2 P \quad (9.18)$$

Waves

- The field is a modification of space-time
- Mode is a particular field configuration for a given boundary value problem. Many field configurations can satisfy Maxwell equations (wave equation). These usually are referred to as modes. A mode is a self-consistent field distribution.
- In a TEM mode, \mathbf{E} and \mathbf{H} are every point in space are constrained in a local plane, independent of time. This plane is called the equiphase plane. In general equiphase planes are not parallel at two different points along the trajectory of the wave.

9.1 PROBLEMS

Exercise 9.1 Spherical wave solutions. (2016 ps7.)

Suppose under some circumstances (e.g. TE' or TM' modes), the partial differential equations for the wavefunction ψ can further be simplified to

$$\nabla^2 \psi(r, \theta, \phi) = -\beta^2 \psi(r, \theta, \phi). \quad (9.19)$$

Using separation of variables

$$\psi(r, \theta, \phi) = R(r)T(\theta)P(\phi), \quad (9.20)$$

find the differential equations governing the behaviour of R , T , P . Comment on the differential equations found and their possible solutions.

Remarks : To have a more uniform answer, making it easier to mark the questions, use the following conventions (notations) in your answer.

- Use $-m^2$ as the constant of separation for the differential equation governing $P(\phi)$.
- Use $-n(n+1)$ as the constant of separation for the differential equation governing $T(\theta)$.
- Show that $R(r)$ follows the differential equation associated with spherical Bessel or Hankel functions.

Answer for Exercise 9.1

PROBLEM SET RELATED MATERIAL REDACTED IN THIS DOCUMENT.PLEASE FEEL FREE TO EMAIL ME FOR THE FULL VERSION IF YOU AREN'T TAKING ECE1228.

[REDACTED]
 [REDACTED]
 [REDACTED]
 [REDACTED]
 [REDACTED]
 [REDACTED]
 [REDACTED]
 [REDACTED]
 [REDACTED] END-REDACTION

Exercise 9.2 Orthogonality conditions for the fields.

Consider plane waves

$$\begin{aligned}\mathbf{E} &= \mathbf{E}_0 e^{-j\mathbf{k}\cdot\mathbf{r}+j\omega t} \\ \mathbf{H} &= \mathbf{H}_0 e^{-j\mathbf{k}\cdot\mathbf{r}+j\omega t}\end{aligned}\tag{9.21}$$

propagating in a homogeneous, lossless, source free region for which $\epsilon > 0$, $\mu > 0$, and where $\mathbf{E}_0, \mathbf{H}_0$ are constant.

- Show that $\mathbf{k} \perp \mathbf{E}$ and $\mathbf{k} \perp \mathbf{H}$.
- Show that $\mathbf{k}, \mathbf{E}, \mathbf{H}$ form a right hand triplet as indicated in fig. 9.1.

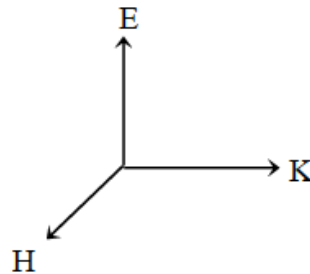

Figure 9.1: Right handed triplet.

Hint: show that $\mathbf{k} \times \mathbf{E} = \omega\mu\mathbf{H}$ and $\mathbf{k} \times \mathbf{H} = -\omega\epsilon\mathbf{E}$.

- Now suppose $\epsilon, \mu < 0$, how does the figure change? Redraw the figure.

Answer for Exercise 9.2

PROBLEM SET RELATED MATERIAL REDACTED IN THIS DOCUMENT. PLEASE
 FEEL FREE TO EMAIL ME FOR THE FULL VERSION IF YOU AREN'T TAKING ECE1228. [REDACTED]

[REDACTED]
 [REDACTED]
 [REDACTED]
 [REDACTED]
 [REDACTED]

[REDACTED]
[REDACTED]
[REDACTED]
[REDACTED]
[REDACTED]
[REDACTED]. END-REDACTION

QUADRUPOLE EXPANSION

Quadrupole potential In Jackson [8], is the following

$$\frac{1}{|\mathbf{x} - \mathbf{x}'|} = 4\pi \sum_{l=0}^{\infty} \sum_{m=-l}^l \frac{1}{2l+1} \frac{(r')^l}{r^{l+1}} Y_{l,m}^*(\theta', \phi') Y_{l,m}(\theta, \phi), \quad (10.1)$$

where $Y_{l,m}$ are the spherical harmonics. It appears that this is actually just an orthogonal function expansion of the inverse distance (for a region outside of the charge density). The proof of this in is scattered through chapter 3, dependent on a similar expansion in Legendre polynomials, for an the azimuthally symmetric configuration.

It looks like quite a project to get comfortable enough with these special functions to fully reproduce the proof of this identity. We are forced to play engineer, and assume the mathematics works out. If we do that and plug this inverse distance formula into the potential we have

$$\begin{aligned} \phi(\mathbf{x}) &= \frac{1}{4\pi\epsilon_0} \int \frac{\rho(\mathbf{x}') d^3 x'}{|\mathbf{x} - \mathbf{x}'|} \\ &= \frac{1}{4\pi\epsilon_0} \int \rho(\mathbf{x}') d^3 x' \left(4\pi \sum_{l=0}^{\infty} \sum_{m=-l}^l \frac{1}{2l+1} \frac{(r')^l}{r^{l+1}} Y_{l,m}^*(\theta', \phi') Y_{l,m}(\theta, \phi) \right) \\ &= \frac{1}{\epsilon_0} \sum_{l=0}^{\infty} \sum_{m=-l}^l \frac{1}{2l+1} \int \rho(\mathbf{x}') d^3 x' \left(\frac{(r')^l}{r^{l+1}} Y_{l,m}^*(\theta', \phi') Y_{l,m}(\theta, \phi) \right) \\ &= \frac{1}{\epsilon_0} \sum_{l=0}^{\infty} \sum_{m=-l}^l \frac{1}{2l+1} \left(\int (r')^l \rho(\mathbf{x}') Y_{l,m}^*(\theta', \phi') d^3 x' \right) \frac{Y_{l,m}(\theta, \phi)}{r^{l+1}} \end{aligned} \quad (10.2)$$

The integral terms are called the coefficients of the multipole moments, denoted

$$q_{l,m} = \int (r')^l \rho(\mathbf{x}') Y_{l,m}^*(\theta', \phi') d^3 x', \quad (10.3)$$

The $l = 0, 1, 2$ terms are, respectively, called the monopole, dipole, and quadrupole terms of the potential

$$\phi(\mathbf{x}) = \frac{1}{4\pi\epsilon_0} \sum_{l=0}^{\infty} \sum_{m=-l}^l \frac{4\pi}{2l+1} q_{l,m} \frac{Y_{l,m}(\theta, \phi)}{r^{l+1}}. \quad (10.4)$$

Note the power of this expansion. Should we wish to compute the electric field, we have only to compute the gradient of the last ($Y_{l,m} r^{-l-1}$) portion (since $q_{l,m}$ is a constant).

$$\begin{aligned}
q_{1,1} &= - \int \sqrt{\frac{3}{8\pi}} \sin \theta' e^{-i\phi'} r' \rho(\mathbf{x}') dV' \\
&= - \sqrt{\frac{3}{8\pi}} \int \sin \theta' (\cos \phi' - i \sin \phi') r' \rho(\mathbf{x}') dV' \\
&= - \sqrt{\frac{3}{8\pi}} \left(\int x' \rho(\mathbf{x}') dV' - i \int y' \rho(\mathbf{x}') dV' \right) \\
&= - \sqrt{\frac{3}{8\pi}} (p_x - ip_y).
\end{aligned} \tag{10.5}$$

Here we've used

$$\begin{aligned}
x' &= r' \sin \theta' \cos \phi' \\
y' &= r' \sin \theta' \sin \phi' \\
z' &= r' \cos \theta'
\end{aligned} \tag{10.6}$$

and the Y_{11} representation

$$\begin{aligned}
Y_{00} &= - \sqrt{\frac{1}{4\pi}} \\
Y_{11} &= - \sqrt{\frac{3}{8\pi}} \sin \theta e^{i\phi} \\
Y_{10} &= \sqrt{\frac{3}{4\pi}} \cos \theta \\
Y_{22} &= - \frac{1}{4} \sqrt{\frac{15}{2\pi}} \sin^2 \theta e^{2i\phi} \\
Y_{21} &= \frac{1}{2} \sqrt{\frac{15}{2\pi}} \sin \theta \cos \theta e^{i\phi} \\
Y_{20} &= \frac{1}{4} \sqrt{\frac{5}{\pi}} (3 \cos^2 \theta - 1)
\end{aligned} \tag{10.7}$$

With the usual dipole moment expression

$$\mathbf{p} = \int \mathbf{x}' \rho(\mathbf{x}') d^3 x', \tag{10.8}$$

and a quadrupole moment defined as

$$Q_{i,j} = \int (3x'_i x'_j - \delta_{ij} (r')^2) \rho(\mathbf{x}') d^3 x', \tag{10.9}$$

the first order terms of the potential are now fully specified

$$\phi(\mathbf{x}) = \frac{1}{4\pi\epsilon_0} \left(q + \frac{\mathbf{p} \cdot \mathbf{x}}{r^3} + \frac{1}{2} \sum_{ij} Q_{ij} \frac{x_i x_j}{r^5} \right). \tag{10.10}$$

Explicit moment and quadrupole expansion We calculated the $q_{1,1}$ coefficient of the electrostatic moment, as covered in [8] chapter 4. Let's verify the rest, as well as the tensor sum formula for the quadrupole moment, and the spherical harmonic sum that yields the dipole moment potential.

The quadrupole term of the potential was stated to be

$$\frac{1}{4\pi\epsilon_0} \frac{4\pi}{5r^3} \sum_{m=-2}^2 \int (r')^2 \rho(\mathbf{x}') Y_{lm}^*(\theta', \phi') Y_{lm}(\theta, \phi) = \frac{1}{2} \sum_{ij} Q_{ij} \frac{x_i x_j}{r^5}, \quad (10.11)$$

where

$$Q_{i,j} = \int (3x'_i x'_j - \delta_{ij} (r')^2) \rho(\mathbf{x}') d^3 x'. \quad (10.12)$$

Let's verify this. First note that

$$Y_{l,m} = \sqrt{\frac{2l+1}{4\pi} \frac{(l-m)!}{(l+m)!}} P_l^m(\cos \theta) e^{im\phi}, \quad (10.13)$$

and

$$P_l^{-m}(x) = (-1)^m \frac{(l-m)!}{(l+m)!} P_l^m(x), \quad (10.14)$$

so

$$\begin{aligned} Y_{l,-m} &= \sqrt{\frac{2l+1}{4\pi} \frac{(l+m)!}{(l-m)!}} P_l^{-m}(\cos \theta) e^{-im\phi} \\ &= (-1)^m \sqrt{\frac{2l+1}{4\pi} \frac{(l-m)!}{(l+m)!}} P_l^m(x) e^{-im\phi} \\ &= (-1)^m Y_{l,m}^*. \end{aligned} \quad (10.15)$$

That means

$$\begin{aligned} q_{l,-m} &= \int (r')^l \rho(\mathbf{x}') Y_{l,-m}^*(\theta', \phi') d^3 x' \\ &= (-1)^m \int (r')^l \rho(\mathbf{x}') Y_{l,m}(\theta', \phi') d^3 x' \\ &= (-1)^m q_{lm}^*. \end{aligned} \quad (10.16)$$

In particular, for $m \neq 0$

$$\begin{aligned}
& (r')^l Y_{l,m}^*(\theta', \phi') r^l Y_{l,m}(\theta, \phi) + (r')^l Y_{l,-m}^*(\theta', \phi') r^l Y_{l,-m}(\theta, \phi) \\
& = (r')^l Y_{l,m}^*(\theta', \phi') r^l Y_{l,m}(\theta, \phi) + (r')^l Y_{l,m}(\theta', \phi') r^l Y_{l,m}^*(\theta, \phi),
\end{aligned} \tag{10.17}$$

or

$$(r')^l Y_{l,m}^*(\theta', \phi') r^l Y_{l,m}(\theta, \phi) + (r')^l Y_{l,-m}^*(\theta', \phi') r^l Y_{l,-m}(\theta, \phi) = 2 \operatorname{Re} \left((r')^l Y_{l,m}^*(\theta', \phi') r^l Y_{l,m}(\theta, \phi) \right). \tag{10.18}$$

To verify the quadrupole expansion formula in a compact way it is helpful to compute some intermediate results.

$$\begin{aligned}
rY_{1,1} &= -r \sqrt{\frac{3}{8\pi}} \sin \theta e^{i\phi} \\
&= -\sqrt{\frac{3}{8\pi}} (x + iy),
\end{aligned} \tag{10.19}$$

$$\begin{aligned}
rY_{1,0} &= r \sqrt{\frac{3}{4\pi}} \cos \theta \\
&= \sqrt{\frac{3}{4\pi}} z,
\end{aligned} \tag{10.20}$$

$$\begin{aligned}
r^2 Y_{2,2} &= -r^2 \sqrt{\frac{15}{32\pi}} \sin^2 \theta e^{2i\phi} \\
&= -\sqrt{\frac{15}{32\pi}} (x + iy)^2,
\end{aligned} \tag{10.21}$$

$$\begin{aligned}
r^2 Y_{2,1} &= r^2 \sqrt{\frac{15}{8\pi}} \sin \theta \cos \theta e^{i\phi} \\
&= \sqrt{\frac{15}{8\pi}} z(x + iy),
\end{aligned} \tag{10.22}$$

$$\begin{aligned}
r^2 Y_{2,0} &= r^2 \sqrt{\frac{5}{16\pi}} (3 \cos^2 \theta - 1) \\
&= \sqrt{\frac{5}{16\pi}} (3z^2 - r^2).
\end{aligned} \tag{10.23}$$

Given primed coordinates and integrating the conjugate of each of these with $\rho(\mathbf{x}')dV'$, we obtain the q_{lm} moment coefficients. Those are

$$q_{11} = -\sqrt{\frac{3}{8\pi}} \int d^3x' \rho(\mathbf{x}') (x - iy), \quad (10.24)$$

$$q_{1,0} = \sqrt{\frac{3}{4\pi}} \int d^3x' \rho(\mathbf{x}') z', \quad (10.25)$$

$$q_{2,2} = -\sqrt{\frac{15}{32\pi}} \int d^3x' \rho(\mathbf{x}') (x' - iy')^2, \quad (10.26)$$

$$q_{2,1} = \sqrt{\frac{15}{8\pi}} \int d^3x' \rho(\mathbf{x}') z' (x' - iy'), \quad (10.27)$$

$$q_{2,0} = \sqrt{\frac{5}{16\pi}} \int d^3x' \rho(\mathbf{x}') (3(z')^2 - (r')^2). \quad (10.28)$$

For the potential we are interested in

$$\begin{aligned} 2 \operatorname{Re} q_{11} r^2 Y_{11}(\theta, \phi) &= 2 \frac{3}{8\pi} \int d^3x' \rho(\mathbf{x}') \operatorname{Re}((x' - iy')(x + iy)) \\ &= \frac{3}{4\pi} \int d^3x' \rho(\mathbf{x}') (xx' + yy'), \end{aligned} \quad (10.29)$$

$$q_{1,0} r Y_{1,0}(\theta, \phi) = \frac{3}{4\pi} \int d^3x' \rho(\mathbf{x}') z' z, \quad (10.30)$$

$$\begin{aligned} 2 \operatorname{Re} q_{22} r^2 Y_{22}(\theta, \phi) &= 2 \frac{15}{32\pi} \int d^3x' \rho(\mathbf{x}') \operatorname{Re}((x' - iy')^2 (x + iy)^2) \\ &= \frac{15}{16\pi} \int d^3x' \rho(\mathbf{x}') \operatorname{Re}(((x')^2 - 2ix'y' - (y')^2)(x^2 + 2ixy - y^2)) \\ &= \frac{15}{16\pi} \int d^3x' \rho(\mathbf{x}') ((x')^2 - (y')^2)(x^2 - y^2) + 4xx'yy', \end{aligned} \quad (10.31)$$

$$\begin{aligned} 2 \operatorname{Re} q_{21} r^2 Y_{21}(\theta, \phi) &= 2 \frac{15}{8\pi} \int d^3x' \rho(\mathbf{x}') z \operatorname{Re}((x' - iy')(x + iy)) \\ &= \frac{15}{4\pi} \int d^3x' \rho(\mathbf{x}') z (xx' + yy'), \end{aligned} \quad (10.32)$$

and

$$q_{2,0}r^2Y_{20}(\theta, \phi) = \frac{5}{16\pi} \int d^3x' \rho(\mathbf{x}') (3(z')^2 - (r')^2) (3z^2 - r^2). \quad (10.33)$$

The dipole term of the potential is

$$\begin{aligned} & \frac{1}{4\pi\epsilon_0} \frac{4\pi}{3r^3} \left(\frac{3}{4\pi} \int d^3x' \rho(\mathbf{x}') (xx' + yy') + \frac{3}{4\pi} \int d^3x' \rho(\mathbf{x}') z'z \right) \\ &= \frac{1}{4\pi\epsilon_0 r^3} \mathbf{x} \cdot \int d^3x' \rho(\mathbf{x}') \mathbf{x}' \\ &= \frac{\mathbf{x} \cdot \mathbf{p}}{4\pi\epsilon_0 r^3}, \end{aligned} \quad (10.34)$$

as obtained directly when a strict dipole approximation was used.

Summing all the terms for the quadrupole gives

$$\begin{aligned} & \frac{1}{4\pi\epsilon r^5} \frac{4\pi}{5} \left(\frac{15}{16\pi} \int d^3x' \rho(\mathbf{x}') ((x')^2 - (y')^2)(x^2 - y^2) + 4xx'yy' \right) \\ & \quad + \frac{15}{4\pi} \int d^3x' \rho(\mathbf{x}') zz' (xx' + yy') \\ & \quad + \frac{5}{16\pi} \int d^3x' \rho(\mathbf{x}') (3(z')^2 - (r')^2) (3z^2 - r^2) \\ &= \frac{1}{4\pi\epsilon r^5} \int d^3x' \rho(\mathbf{x}') \frac{1}{4} \left(3((x')^2 - (y')^2)(x^2 - y^2) + 4xx'yy' \right) \\ & \quad + 12zz' (xx' + yy') \\ & \quad + (3(z')^2 - (r')^2) (3z^2 - r^2). \end{aligned} \quad (10.35)$$

The portion in brackets is

$$\begin{aligned} & 3((x')^2 - (y')^2)(x^2 - y^2) + 4xx'yy' \\ & + 12zz' (xx' + yy') \\ & + (2(z')^2 - (x')^2 - (y')^2) (2z^2 - x^2 - y^2) \\ &= x^2 (3(x')^2 - 3(y')^2 - (2(z')^2 - (x')^2 - (y')^2)) \\ & + y^2 (-3(x')^2 + 3(y')^2 - (2(z')^2 - (x')^2 - (y')^2)) \\ & + 2z^2 (2(z')^2 - (x')^2 - (y')^2) \\ & \quad + 12xx'yy' + xx'zz' + yy'zz' \\ &= 2x^2 (2(x')^2 - (y')^2 - (z')^2) \\ & + 2y^2 (2(y')^2 - (x')^2 - (z')^2) \\ & + 2z^2 (2(z')^2 - (x')^2 - (y')^2) \\ & \quad + 12xx'yy' + xx'zz' + yy'zz'. \end{aligned} \quad (10.36)$$

The quadrupole sum can now be written as

$$\frac{1}{2} \frac{1}{4\pi\epsilon r^5} \int d^3x' \rho(\mathbf{x}') (x^2 (3(x')^2 - (r')^2) + y^2 (3(y')^2 - (r')^2) + z^2 (3(z')^2 - (r')^2) + 3(xy x' y' + yx y' x' + xz x' z' + zx z' x' + yz y' z' + zy z' y')), \quad (10.37)$$

which is precisely eq. (10.11), the quadrupole potential stated in the text and class notes.

10.1 PROBLEMS

Exercise 10.1 Dipole multipole moment.

Following Jackson [8], derive the electric field contribution from the dipole terms of the multipole sum, but don't skip the details.

Answer for Exercise 10.1

PROBLEM SET RELATED MATERIAL REDACTED IN THIS DOCUMENT. PLEASE FEEL FREE TO EMAIL ME FOR THE FULL VERSION IF YOU AREN'T TAKING ECE1228.

REDACTED CONTENT BLOCK

END-REDACTION

FRESNEL RELATIONS

11.1 SINGLE INTERFACE TE MODE.

The Fresnel reflection geometry for an electric field \mathbf{E} parallel to the interface (TE mode) is sketched in fig. 11.1.

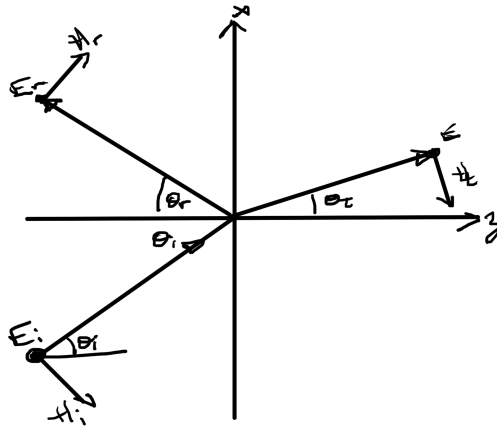

Figure 11.1: Electric field TE mode Fresnel geometry.

$$\mathcal{E}_i = \mathbf{e}_2 E_i e^{j\omega t - j\mathbf{k}_i \cdot \mathbf{x}}, \quad (11.1)$$

with an assumption that this field maintains its polarization in both its reflected and transmitted components, so that

$$\mathcal{E}_r = \mathbf{e}_2 r E_i e^{j\omega t - j\mathbf{k}_r \cdot \mathbf{x}}, \quad (11.2)$$

and

$$\mathcal{E}_t = \mathbf{e}_2 t E_i e^{j\omega t - j\mathbf{k}_t \cdot \mathbf{x}}, \quad (11.3)$$

Measuring the angles $\theta_i, \theta_r, \theta_t$ from the normal, with $i = \mathbf{e}_3 \mathbf{e}_1$ the wave vectors are

$$\begin{aligned} \mathbf{k}_i &= \mathbf{e}_3 k_1 e^{i\theta_i} = k_1 (\mathbf{e}_3 \cos \theta_i + \mathbf{e}_1 \sin \theta_i) \\ \mathbf{k}_r &= -\mathbf{e}_3 k_1 e^{-i\theta_r} = k_1 (-\mathbf{e}_3 \cos \theta_r + \mathbf{e}_1 \sin \theta_r) \\ \mathbf{k}_t &= \mathbf{e}_3 k_2 e^{i\theta_t} = k_2 (\mathbf{e}_3 \cos \theta_t + \mathbf{e}_1 \sin \theta_t) \end{aligned} \quad (11.4)$$

So the time harmonic electric fields are

$$\begin{aligned}
 \mathbf{E}_i &= \mathbf{e}_2 E_i \exp(-jk_1(z \cos \theta_i + x \sin \theta_i)) \\
 \mathbf{E}_r &= \mathbf{e}_2 r E_i \exp(-jk_1(-z \cos \theta_r + x \sin \theta_r)) \\
 \mathbf{E}_t &= \mathbf{e}_2 t E_i \exp(-jk_2(z \cos \theta_t + x \sin \theta_t)).
 \end{aligned} \tag{11.5}$$

The magnetic fields follow from Faraday's law

$$\begin{aligned}
 \mathbf{H} &= \frac{1}{-j\omega\mu} \nabla \times \mathbf{E} \\
 &= \frac{1}{-j\omega\mu} \nabla \times \mathbf{e}_2 e^{-j\mathbf{k} \cdot \mathbf{x}} \\
 &= \frac{1}{j\omega\mu} \mathbf{e}_2 \times \nabla e^{-j\mathbf{k} \cdot \mathbf{x}} \\
 &= -\frac{1}{\omega\mu} \mathbf{e}_2 \times \mathbf{k} e^{-j\mathbf{k} \cdot \mathbf{x}} \\
 &= \frac{1}{\omega\mu} \mathbf{k} \times \mathbf{E}
 \end{aligned} \tag{11.6}$$

We have

$$\begin{aligned}
 \hat{\mathbf{k}}_i \times \mathbf{e}_2 &= -\mathbf{e}_1 \cos \theta_i + \mathbf{e}_3 \sin \theta_i \\
 \hat{\mathbf{k}}_r \times \mathbf{e}_2 &= \mathbf{e}_1 \cos \theta_r + \mathbf{e}_3 \sin \theta_r \\
 \hat{\mathbf{k}}_t \times \mathbf{e}_2 &= -\mathbf{e}_1 \cos \theta_t + \mathbf{e}_3 \sin \theta_t,
 \end{aligned} \tag{11.7}$$

Note that

$$\begin{aligned}
 \frac{k}{\omega\mu} &= \frac{k}{kv\mu} \\
 &= \frac{\sqrt{\mu\epsilon}}{\mu} \\
 &= \sqrt{\frac{\epsilon}{\mu}} \\
 &= \frac{1}{\eta}.
 \end{aligned} \tag{11.8}$$

so

$$\begin{aligned}
 \mathbf{H}_i &= \frac{E_i}{\eta_1} (-\mathbf{e}_1 \cos \theta_i + \mathbf{e}_3 \sin \theta_i) \exp(-jk_1(z \cos \theta_i + x \sin \theta_i)) \\
 \mathbf{H}_r &= \frac{rE_i}{\eta_1} (\mathbf{e}_1 \cos \theta_r + \mathbf{e}_3 \sin \theta_r) \exp(-jk_1(-z \cos \theta_r + x \sin \theta_r)) \\
 \mathbf{H}_t &= \frac{tE_i}{\eta_2} (-\mathbf{e}_1 \cos \theta_t + \mathbf{e}_3 \sin \theta_t) \exp(-jk_2(z \cos \theta_t + x \sin \theta_t)).
 \end{aligned} \tag{11.9}$$

The boundary conditions at $z = 0$ with $\hat{\mathbf{n}} = \mathbf{e}_3$ are

$$\begin{aligned}\hat{\mathbf{n}} \times \mathbf{H}_1 &= \hat{\mathbf{n}} \times \mathbf{H}_2 \\ \hat{\mathbf{n}} \cdot \mathbf{B}_1 &= \hat{\mathbf{n}} \cdot \mathbf{B}_2 \\ \hat{\mathbf{n}} \times \mathbf{E}_1 &= \hat{\mathbf{n}} \times \mathbf{E}_2 \\ \hat{\mathbf{n}} \cdot \mathbf{D}_1 &= \hat{\mathbf{n}} \cdot \mathbf{D}_2,\end{aligned}\tag{11.10}$$

At $x = 0$, this is

$$\begin{aligned}-\frac{1}{\eta_1} \cos \theta_i + \frac{r}{\eta_1} \cos \theta_r &= -\frac{t}{\eta_2} \cos \theta_t \\ k_1 \sin \theta_i + k_1 r \sin \theta_r &= k_2 t \sin \theta_t \\ 1 + r &= t\end{aligned}\tag{11.11}$$

When $t = 0$ the latter two equations give Shell's first law

$$\boxed{\sin \theta_i = \sin \theta_r.}\tag{11.12}$$

Assuming this holds for all r, t we have

$$k_1 \sin \theta_i (1 + r) = k_2 t \sin \theta_t,\tag{11.13}$$

which is Snell's second law in disguise

$$k_1 \sin \theta_i = k_2 \sin \theta_t.\tag{11.14}$$

With

$$\begin{aligned}k &= \frac{\omega}{v} \\ &= \frac{\omega c}{c v} \\ &= \frac{\omega}{c} n,\end{aligned}\tag{11.15}$$

so eq. (11.14) takes the form

$$\boxed{n_1 \sin \theta_i = n_2 \sin \theta_t.}\tag{11.16}$$

With

$$\begin{aligned}k_{1z} &= k_1 \cos \theta_i \\ k_{2z} &= k_2 \cos \theta_t,\end{aligned}\tag{11.17}$$

we can solve for r, t by inverting

$$\begin{bmatrix} \mu_2 k_{1z} & \mu_1 k_{2z} \\ -1 & 1 \end{bmatrix} \begin{bmatrix} r \\ t \end{bmatrix} = \begin{bmatrix} \mu_2 k_{1z} \\ 1 \end{bmatrix}, \quad (11.18)$$

which gives

$$\begin{bmatrix} r \\ t \end{bmatrix} = \begin{bmatrix} 1 & -\mu_1 k_{2z} \\ 1 & \mu_2 k_{1z} \end{bmatrix} \begin{bmatrix} \mu_2 k_{1z} \\ 1 \end{bmatrix}, \quad (11.19)$$

or

$$\boxed{\begin{aligned} r &= \frac{\mu_2 k_{1z} - \mu_1 k_{2z}}{\mu_2 k_{1z} + \mu_1 k_{2z}} \\ t &= \frac{2\mu_2 k_{1z}}{\mu_2 k_{1z} + \mu_1 k_{2z}} \end{aligned}} \quad (11.20)$$

There are many ways that this can be written. Dividing both the numerator and denominator by $\mu_1 \mu_2 \omega / c$, and noting that $k = \omega n / c$, we have

$$\begin{aligned} r &= \frac{\frac{n_1}{\mu_1} \cos \theta_i - \frac{n_2}{\mu_2} \cos \theta_t}{\frac{n_1}{\mu_1} \cos \theta_i + \frac{n_2}{\mu_2} \cos \theta_t} \\ t &= \frac{2 \frac{n_1}{\mu_1} \cos \theta_i}{\frac{n_1}{\mu_1} \cos \theta_i + \frac{n_2}{\mu_2} \cos \theta_t}, \end{aligned} \quad (11.21)$$

which checks against (4.32,4.33) in [6].

11.2 SINGLE INTERFACE TM MODE.

For completeness, now consider the TM mode.

Faraday's law also can provide the electric field from the magnetic

$$\begin{aligned} \hat{\mathbf{k}} \times \mathbf{H} &= \eta \hat{\mathbf{k}} \times (\hat{\mathbf{k}} \times \mathbf{E}) \\ &= -\eta \hat{\mathbf{k}} \cdot (\hat{\mathbf{k}} \wedge \mathbf{E}) \\ &= -\eta (\mathbf{E} - \hat{\mathbf{k}} (\hat{\mathbf{k}} \cdot \mathbf{E})) \\ &= -\eta \mathbf{E}. \end{aligned} \quad (11.22)$$

so

$$\mathbf{E} = \eta \mathbf{H} \times \hat{\mathbf{k}}. \quad (11.23)$$

So the magnetic and electric fields are

$$\begin{aligned}
 \mathbf{H}_i &= \mathbf{e}_2 \frac{E_i}{\eta_1} \exp(-jk_1(z \cos \theta_i + x \sin \theta_i)) \\
 \mathbf{H}_r &= \mathbf{e}_2 r \frac{E_i}{\eta_1} \exp(-jk_1(-z \cos \theta_r + x \sin \theta_r)) \\
 \mathbf{H}_t &= \mathbf{e}_2 t \frac{E_i}{\eta_2} \exp(-jk_2(z \cos \theta_t + x \sin \theta_t))
 \end{aligned} \tag{11.24a}$$

$$\begin{aligned}
 \mathbf{E}_i &= -E_i(-\mathbf{e}_1 \cos \theta_i + \mathbf{e}_3 \sin \theta_i) \exp(-jk_1(z \cos \theta_i + x \sin \theta_i)) \\
 \mathbf{E}_r &= -rE_i(\mathbf{e}_1 \cos \theta_r + \mathbf{e}_3 \sin \theta_r) \exp(-jk_1(-z \cos \theta_r + x \sin \theta_r)) \\
 \mathbf{E}_t &= -tE_i(-\mathbf{e}_1 \cos \theta_t + \mathbf{e}_3 \sin \theta_t) \exp(-jk_2(z \cos \theta_t + x \sin \theta_t)).
 \end{aligned} \tag{11.24b}$$

Imposing the constraints eq. (11.10), at $x = z = 0$ we have

$$\begin{aligned}
 \frac{1}{\eta_1} (1 + r) &= \frac{t}{\eta_2} \\
 \cos \theta_i - r \cos \theta_r &= t \cos \theta_t \\
 \epsilon_1 (\sin \theta_i + r \sin \theta_r) &= t \epsilon_2 \sin \theta_t
 \end{aligned} \tag{11.25}$$

At $t = 0$, the first and third of these give $\theta_i = \theta_r$. Assuming this incident and reflection angle equality holds for all values of t , we have

$$\begin{aligned}
 \sin \theta_i (1 + r) &= t \frac{\epsilon_2}{\epsilon_1} \sin \theta_t \\
 \sin \theta_i \frac{\eta_1}{\eta_2} t &=
 \end{aligned} \tag{11.26}$$

or

$$\epsilon_1 \eta_1 \sin \theta_i = \epsilon_2 \eta_2 \sin \theta_t. \tag{11.27}$$

This is also Snell's second law eq. (11.16) in disguise, which can be seen by

$$\begin{aligned}
 \epsilon_1 \eta_1 &= \epsilon_1 \sqrt{\frac{\mu_1}{\epsilon_1}} \\
 &= \sqrt{\epsilon_1 \mu_1} \\
 &= \frac{1}{v} \\
 &= \frac{n}{c}.
 \end{aligned} \tag{11.28}$$

The remaining equations in matrix form are

$$\begin{bmatrix} \cos \theta_i & \cos \theta_t \\ -1 & \frac{\eta_1}{\eta_2} \end{bmatrix} \begin{bmatrix} r \\ t \end{bmatrix} = \begin{bmatrix} \cos \theta_i \\ 1 \end{bmatrix}, \quad (11.29)$$

the inverse of which is

$$\begin{aligned} \begin{bmatrix} r \\ t \end{bmatrix} &= \frac{1}{\frac{\eta_1}{\eta_2} \cos \theta_i + \cos \theta_t} \begin{bmatrix} \frac{\eta_1}{\eta_2} & -\cos \theta_t \\ 1 & \cos \theta_i \end{bmatrix} \begin{bmatrix} \cos \theta_i \\ 1 \end{bmatrix} \\ &= \frac{1}{\frac{\eta_1}{\eta_2} \cos \theta_i + \cos \theta_t} \begin{bmatrix} \frac{\eta_1}{\eta_2} \cos \theta_i - \cos \theta_t \\ 2 \cos \theta_i \end{bmatrix}, \end{aligned} \quad (11.30)$$

or

$$\boxed{\begin{aligned} r &= \frac{\eta_1 \cos \theta_i - \eta_2 \cos \theta_t}{\eta_1 \cos \theta_i + \eta_2 \cos \theta_t} \\ t &= \frac{2\eta_2 \cos \theta_i}{\eta_1 \cos \theta_i + \eta_2 \cos \theta_t}. \end{aligned}} \quad (11.31)$$

Multiplication of the numerator and denominator by $c/\eta_1\eta_2$, noting that $c/\eta = n/\mu$ gives

$$\begin{aligned} r &= \frac{\frac{\eta_2}{\mu_2} \cos \theta_i - \frac{\eta_1}{\mu_1} \cos \theta_t}{\frac{\eta_2}{\mu_2} \cos \theta_i + \frac{\eta_1}{\mu_1} \cos \theta_t} \\ t &= \frac{2\frac{\eta_1}{\mu_1} \cos \theta_i}{\frac{\eta_2}{\mu_2} \cos \theta_i + \frac{\eta_1}{\mu_1} \cos \theta_t} \end{aligned} \quad (11.32)$$

which checks against (4.38,4.39) in [6].

11.3 NORMAL TRANSMISSION AND REFLECTION THROUGH TWO INTERFACES.

The geometry of a two interface configuration is sketched in fig. 11.2.

Given a normal incident ray with magnitude A , the respective forward and backwards rays in each the mediums can be written as

$$\begin{aligned} \text{I} \\ \rightarrow & Ae^{-jk_{1z}z} \\ \leftarrow & Are^{jk_{1z}z} \end{aligned} \quad (11.33)$$

$$\begin{aligned} \text{II} \\ \rightarrow & Ce^{-jk_{2z}z} \\ \leftarrow & De^{jk_{2z}z} \end{aligned} \quad (11.34)$$

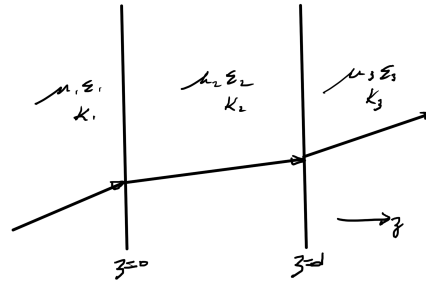

Figure 11.2: Two interface transmission.

III

$$\rightarrow Ate^{-jk_3z(z-d)} \quad (11.35)$$

Matching at $z = 0$ gives

$$\begin{aligned} At_{12} + r_{21}D &= C \\ Ar &= Ar_{12} + Dt_{21}, \end{aligned} \quad (11.36)$$

whereas matching at $z = d$ gives

$$\begin{aligned} At &= Ce^{-jk_2d}t_{23} \\ De^{jk_2d} &= Ce^{-jk_2d}r_{23} \end{aligned} \quad (11.37)$$

We have four linear equations in four unknowns r, t, C, D , but only care about solving for r, t . Let's write $\gamma = e^{jk_2d}$, $C' = C/A$, $D' = D/A$, for

$$\begin{aligned} t_{12} + r_{21}D' &= C' \\ r &= r_{12} + D't_{21} \\ t\gamma &= C't_{23} \\ D'\gamma^2 &= C'r_{23} \end{aligned} \quad (11.38)$$

Solving for C', D' we get

$$\begin{aligned} D'(\gamma^2 - r_{21}r_{23}) &= t_{12}r_{23} \\ C'(\gamma^2 - r_{21}r_{23}) &= t_{12}\gamma^2, \end{aligned} \quad (11.39)$$

so

$$\begin{aligned} r &= r_{12} + \frac{t_{12}t_{21}r_{23}}{\gamma^2 - r_{21}r_{23}} \\ t &= t_{23} \frac{t_{12}\gamma}{\gamma^2 - r_{21}r_{23}}. \end{aligned} \quad (11.40)$$

With $\phi = -jk_{2z}d$, or $\gamma = e^{-j\phi}$, we have

$$\boxed{\begin{aligned} r &= r_{12} + \frac{t_{12}t_{21}r_{23}e^{2j\phi}}{1 - r_{21}r_{23}e^{2j\phi}} \\ t &= \frac{t_{12}t_{23}e^{j\phi}}{1 - r_{21}r_{23}e^{2j\phi}}. \end{aligned}} \quad (11.41)$$

A slab When the materials in region I, and III are equal, then $r_{12} = r_{32}$. For a TE mode, we have

$$r_{12} = \frac{\mu_2 k_{1z} - \mu_1 k_{2z}}{\mu_2 k_{1z} + \mu_1 k_{2z}} = -r_{21}. \quad (11.42)$$

so the reflection and transmission coefficients are

$$\begin{aligned} r^{\text{TE}} &= r_{12} \left(1 - \frac{t_{12}t_{21}e^{2j\phi}}{1 - r_{21}^2 e^{2j\phi}} \right) \\ t^{\text{TE}} &= \frac{t_{12}t_{21}e^{j\phi}}{1 - r_{21}^2 e^{2j\phi}}. \end{aligned} \quad (11.43)$$

It's possible to produce a matched condition for which $r_{12} = r_{21} = 0$, by selecting

$$\begin{aligned} 0 &= \mu_2 k_{1z} - \mu_1 k_{2z} \\ &= \mu_1 \mu_2 \left(\frac{1}{\mu_1} k_{1z} - \frac{1}{\mu_2} k_{2z} \right) \\ &= \mu_1 \mu_2 \omega \left(\frac{1}{v_1 \mu_1} \theta_1 - \frac{1}{v_2 \mu_2} \theta_2 \right), \end{aligned} \quad (11.44)$$

or

$$\frac{1}{\eta_1} \cos \theta_1 = \frac{1}{\eta_2} \cos \theta_2, \quad (11.45)$$

so the matching condition for normal incidence is just

$$\eta_1 = \eta_2. \quad (11.46)$$

Given this matched condition, the transmission coefficient for the 1,2 interface is

$$\begin{aligned} t_{12} &= \frac{2\mu_2 k_{1z}}{\mu_2 k_{1z} + \mu_1 k_{2z}} \\ &= \frac{2\mu_2 k_{1z}}{2\mu_2 k_{1z}} \\ &= 1, \end{aligned} \quad (11.47)$$

so the matching condition yields

$$\begin{aligned} t &= t_{12}t_{21}e^{j\phi} \\ &= e^{j\phi} \\ &= e^{-jk_2z'd}. \end{aligned} \tag{11.48}$$

Normal transmission through a matched slab only introduces a phase delay.

11.4 TOTAL INTERNAL REFLECTION

From Snell's second law we have

$$\theta_t = \arcsin\left(\frac{n_i}{n_t} \sin \theta_i\right). \tag{11.49}$$

This is plotted in fig. 11.3.

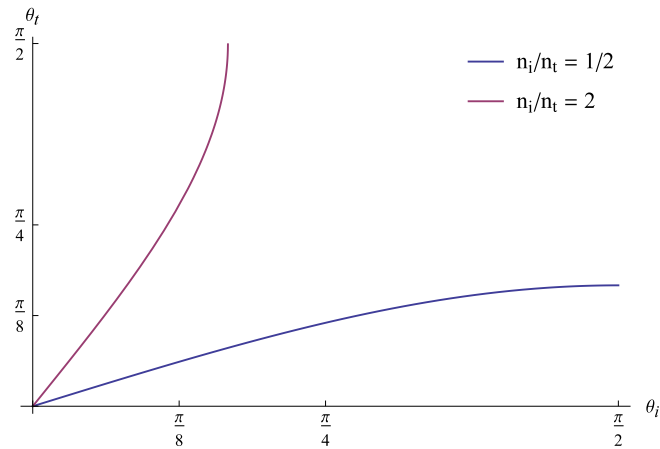

Figure 11.3: Transmission angle vs incident angle.

For the $n_i > n_t$ case, for example, like shining from glass into air, there is a critical incident angle beyond which there is no real value of θ_t . That critical incident angle occurs when $\theta_t = \pi/2$, which is

$$\sin \theta_{ic} = \frac{n_t}{n_i} \sin(\pi/2). \tag{11.50}$$

With

$$n = n_t/n_i \tag{11.51}$$

the critical angle is

$$\theta_{ic} = \arcsin n. \quad (11.52)$$

Note that Snell's law can also be expressed in terms of this critical angle, allowing for the solution of the transmission angle in a convenient way

$$\begin{aligned} \sin \theta_t &= \frac{n_t}{n_i} \sin \theta_i \\ &= n \sin \theta_i \\ &= \sin \theta_{ic} \sin \theta_i, \end{aligned} \quad (11.53)$$

or

$$\sin \theta_t = \frac{\sin \theta_i}{\sin \theta_{ic}}. \quad (11.54)$$

Still for $n_i > n_t$, at angles past θ_{ic} , the transmitted wave angle becomes complex as outlined in [8], namely

$$\begin{aligned} \cos^2 \theta_t &= 1 - \sin^2 \theta_t \\ &= 1 - \frac{\sin^2 \theta_i}{\sin^2 \theta_{ic}} \\ &= -\left(\frac{\sin^2 \theta_i}{\sin^2 \theta_{ic}} - 1 \right), \end{aligned} \quad (11.55)$$

or

$$\cos \theta_t = j \sqrt{\frac{\sin^2 \theta_i}{\sin^2 \theta_{ic}} - 1}. \quad (11.56)$$

Following the convention that puts the normal propagation direction along z , and the interface along x , the wave vector direction is

$$\begin{aligned} \hat{\mathbf{k}}_t &= \mathbf{e}_3 e^{e_{31} \theta_t} \\ &= \mathbf{e}_3 \cos \theta_t + \mathbf{e}_1 \sin \theta_t. \end{aligned} \quad (11.57)$$

The phase factor for the transmitted field is

$$\begin{aligned} \exp(j\omega t \pm j\mathbf{k}_t \cdot \mathbf{x}) &= \exp(j\omega t \pm jk\hat{\mathbf{k}}_t \cdot \mathbf{x}) \\ &= \exp(j\omega t \pm jk(z \cos \theta_t + x \sin \theta_t)) \\ &= \exp\left(j\omega t \pm jk\left(zj\sqrt{\frac{\sin^2 \theta_i}{\sin^2 \theta_{ic}} - 1} + x\frac{\sin \theta_i}{\sin \theta_{ic}}\right)\right) \\ &= \exp\left(j\omega t \pm k\left(jx\frac{\sin \theta_i}{\sin \theta_{ic}} - z\sqrt{\frac{\sin^2 \theta_i}{\sin^2 \theta_{ic}} - 1}\right)\right). \end{aligned} \quad (11.58)$$

The propagation is channelled along the x axis, but the propagation into the second medium decays exponentially (or unphysically grows exponentially), only getting into the surface a small amount.

What is the average power transmission into the medium? We are interested in the time average of the normal component of the Poynting vector $\mathbf{S} \cdot \hat{\mathbf{n}}$.

$$\begin{aligned}
 \mathbf{S} &= \frac{1}{2} \mathbf{E} \times \mathbf{H}^* \\
 &= \frac{1}{2} \mathbf{E} \times \left(\frac{1}{\eta} \hat{\mathbf{k}}_t \times \mathbf{E}^* \right) \\
 &= -\frac{1}{2\eta} \mathbf{E} \cdot (\hat{\mathbf{k}}_t \wedge \mathbf{E}^*) \\
 &= -\frac{1}{2\eta} ((\mathbf{E} \cdot \hat{\mathbf{k}}_t) \mathbf{E}^* - \hat{\mathbf{k}}_t \mathbf{E} \cdot \mathbf{E}^*) \\
 &= \frac{1}{2\eta} \hat{\mathbf{k}}_t |\mathbf{E}|^2.
 \end{aligned} \tag{11.59}$$

$$\begin{aligned}
 \hat{\mathbf{k}}_t \cdot \hat{\mathbf{n}} &= (\mathbf{e}_3 \cos \theta_t + \mathbf{e}_1 \sin \theta_t) \cdot \mathbf{e}_3 \\
 &= \cos \theta_t \\
 &= j \sqrt{\frac{\sin^2 \theta_i}{\sin^2 \theta_{ic}} - 1}.
 \end{aligned} \tag{11.60}$$

Note that this is purely imaginary. The time average real power transmission is

$$\begin{aligned}
 \langle \mathbf{S} \cdot \hat{\mathbf{n}} \rangle &= \text{Re} \left(j \sqrt{\frac{\sin^2 \theta_i}{\sin^2 \theta_{ic}} - 1} \frac{1}{2\eta} |\mathbf{E}|^2 \right) \\
 &= 0.
 \end{aligned} \tag{11.61}$$

There is no power transmission into the second medium at or past the critical angle for total internal reflection.

11.5 BREWSTER'S ANGLE

Brewster's angle is the angle for which there the amplitude of the reflected component of the field is zero. Recall that when the electric field is parallel(perpendicular) to the plane of incidence, the reflection amplitude ([6] eq. 4.38)

$$r_{\parallel} = \frac{\frac{n_i}{\mu_i} \cos \theta_i - \frac{n_t}{\mu_t} \cos \theta_t}{\frac{n_i}{\mu_i} \cos \theta_i + \frac{n_t}{\mu_t} \cos \theta_t} \tag{11.62}$$

$$r_{\perp} = \frac{\frac{n_i}{\mu_i} \cos \theta_i - \frac{n_t}{\mu_t} \cos \theta_t}{\frac{n_i}{\mu_i} \cos \theta_i + \frac{n_t}{\mu_t} \cos \theta_t} \quad (11.63)$$

There are limited conditions for which r_{\perp} is zero, at least for $\mu_i = \mu_t$. Using Snell's second law $n_i \sin \theta_i = n_t \sin \theta_t$, that zero is found at

$$\begin{aligned} n_i \cos \theta_i &= n_t \cos \theta_t \\ &= n_t \sqrt{1 - \sin^2 \theta_t} \\ &= n_t \sqrt{1 - \frac{n_i^2}{n_t^2} \sin^2 \theta_i}, \end{aligned} \quad (11.64)$$

or

$$\frac{n_i^2}{n_t^2} \cos^2 \theta_i = 1 - \frac{n_i^2}{n_t^2} \sin^2 \theta_i, \quad (11.65)$$

or

$$\frac{n_i^2}{n_t^2} (\cos^2 \theta_i + \sin^2 \theta_i) = 1. \quad (11.66)$$

This has solutions only when $n_i = \pm n_t$. The $n_i = n_t$ case is of no interest, since that is just propagation, so naturally there is no reflection. The $n_i = -n_t$ case is possible with the transmission into a negative index of refraction material that is matched in absolute magnitude with the index of refraction in the incident medium.

There are richer solutions for the r_{\parallel} zero. Again considering $\mu_1 = \mu_2$ those occur when

$$\begin{aligned} n_t \cos \theta_i &= n_i \cos \theta_t \\ &= n_i \sqrt{1 - \frac{n_i^2}{n_t^2} \sin^2 \theta_i} \\ &= n_i \sqrt{1 - \frac{n_i^2}{n_t^2} \sin^2 \theta_i} \end{aligned} \quad (11.67)$$

Let $n = n_t/n_i$, and square both sides. This gives

$$\begin{aligned} n^2 \cos^2 \theta_i &= 1 - \frac{1}{n^2} \sin^2 \theta_i \\ &= 1 - \frac{1}{n^2} (1 - \cos^2 \theta_i), \end{aligned} \quad (11.68)$$

or

$$\cos^2 \theta_i \left(n^2 + \frac{1}{n^2} \right) = 1 - \frac{1}{n^2}, \quad (11.69)$$

or

$$\begin{aligned} \cos^2 \theta_i &= \frac{1 - \frac{1}{n^2}}{n^2 - \frac{1}{n^2}} \\ &= \frac{n^2 - 1}{n^4 - 1} \\ &= \frac{n^2 - 1}{(n^2 - 1)(n^2 + 1)} \\ &= \frac{1}{n^2 + 1}. \end{aligned} \quad (11.70)$$

We also have

$$\begin{aligned} \sin^2 \theta_i &= 1 - \frac{1}{n^2 + 1} \\ &= \frac{n^2}{n^2 + 1}, \end{aligned} \quad (11.71)$$

so

$$\tan^2 \theta_i = n^2, \quad (11.72)$$

and

$$\tan \theta_{iB} = \pm n, \quad (11.73)$$

For normal media where $n_i > 0, n_t > 0$, only the positive solution is physically relevant, which is

$$\theta_{iB} = \arctan \left(\frac{n_t}{n_i} \right). \quad (11.74)$$

11.6 PROBLEMS

Exercise 11.1 Fresnel sum and difference formulas. ([6] pr. 4.39)

Given a $\mu_1 = \mu_2$ constraint, show that the Fresnel equations have the form

$$r^{\text{TE}} = \frac{\sin(\theta_t - \theta_i)}{\sin(\theta_t + \theta_i)} \quad (11.75a)$$

$$r^{\text{TM}} = \frac{\tan(\theta_i - \theta_t)}{\tan(\theta_i + \theta_t)} \tag{11.75b}$$

$$t^{\text{TE}} = \frac{2 \sin \theta_t \cos \theta_i}{\sin(\theta_i + \theta_t)} \tag{11.75c}$$

$$t^{\text{TM}} = \sin(\theta_i + \theta_t) \cos(\theta_i - \theta_t). \tag{11.75d}$$

Answer for Exercise 11.1

PROBLEM SET RELATED MATERIAL REDACTED IN THIS DOCUMENT.PLEASE FEEL FREE TO EMAIL ME FOR THE FULL VERSION IF YOU AREN'T TAKING ECE1228.

[REDACTED]

END-REDACTION

Exercise 11.2 Fresnel TM equations.

For the geometry shown in fig. 11.4, obtain the TM (E) Fresnel reflection and transmission coefficients. Express your results in terms of the propagation constant k_{1z} and k_{2z} , (i.e., the projection of \mathbf{k}_1 and \mathbf{k}_2 along z-direction.) Note that the interface is at $z = 0$ plane.

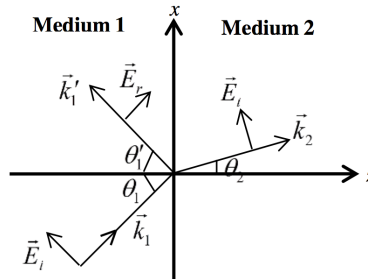

Figure 11.4: TM mode geometry.

Answer for Exercise 11.2

PROBLEM SET RELATED MATERIAL REDACTED IN THIS DOCUMENT.PLEASE FEEL FREE TO EMAIL ME FOR THE FULL VERSION IF YOU AREN'T TAKING ECE1228.

[REDACTED]

[REDACTED] END-REDACTION

Exercise 11.3 Two interfaces.

- a. Give the TE transmission function $T^{TE}(\omega)$ for a slab of length d with permittivity and permeability ϵ_2, μ_2 , surrounded by medium characterized by ϵ_1 and μ_1 as shown in fig. 11.5. Make sure you provide the expressions for the terms appearing in the transmission function $T^{TE}(\omega)$.
- b. Suppose medium (II) is a meta-material with $\epsilon_2 = -\epsilon_1$ and $\mu_2 = -\mu_1$, where $\epsilon_1 > 0$ and $\mu_1 > 0$. What is the transmission function $T^{TE}(\omega)$ in this case. Express your results in terms of the propagation constant in medium (I), i.e. k_{1z} .
- c. Now consider a source located at $z = 0$ generating a uniform plane wave, and for simplicity suppose a one-dimensional propagation. What is the field at the second interface $z = 2d$. What is the meaning of your results?

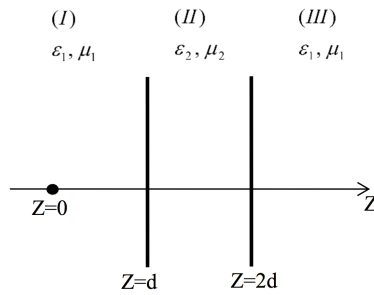
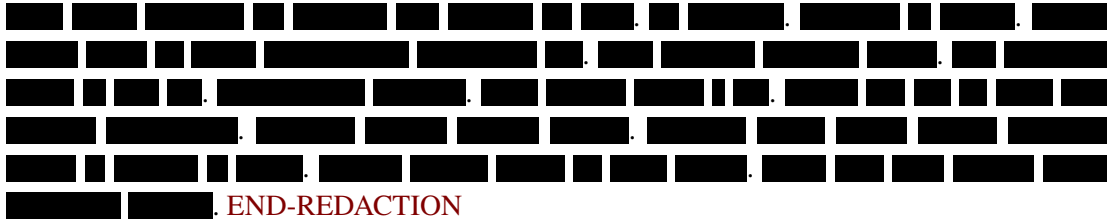

Figure 11.5: Slab geometry.

Answer for Exercise 11.3

PROBLEM SET RELATED MATERIAL REDACTED IN THIS DOCUMENT.PLEASE FEEL FREE TO EMAIL ME FOR THE FULL VERSION IF YOU AREN'T TAKING ECE1228.

[REDACTED]



Exercise 11.4 One dimensional photonic crystal.

Consider an infinitely periodic one dimensional photonic crystal (1DPC) shown in fig. 11.6 below where n_i and n_j are the indices of refractions (in general complex) associated with the regions i and j having thicknesses d_i and d_j . The one period transfer matrix \mathbf{M} relates the fields according to

$$\begin{bmatrix} E'_{l,i} \\ E'_{r,i} \end{bmatrix} = \mathbf{M} \begin{bmatrix} E'_{l,i+1} \\ E'_{r,i+1} \end{bmatrix} \quad (11.76a)$$

$$\mathbf{M} = g \begin{bmatrix} a & b \\ \hat{b} & \hat{a} \end{bmatrix} \quad (11.76b)$$

$$g = \frac{1}{1 - \rho_{i,j}^2}, \quad (11.76c)$$

and $\rho_{i,j}$ is the Fresnel coefficient. Give the expressions for a, \hat{a}, b, \hat{b} in terms of β_i, β_j , and $\rho_{i,j}$ where the phase constants in regions i and j are

$$\beta_i = \frac{\omega}{c} n_i d_i \cos \theta_i \quad (11.77a)$$

$$\beta_j = \frac{\omega}{c} n_j d_j \cos \theta_j, \quad (11.77b)$$

and θ_i or θ_j are the incident angles.

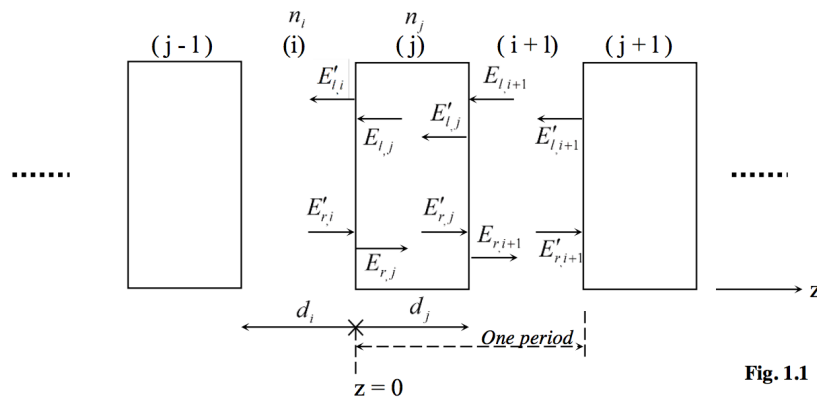

Fig. 1.1

Figure 11.6: 1DPC photonic crystal.

Answer for Exercise 11.4

PROBLEM SET RELATED MATERIAL REDACTED IN THIS DOCUMENT. PLEASE FEEL FREE TO EMAIL ME FOR THE FULL VERSION IF YOU AREN'T TAKING ECE1228. [REDACTED]

[REDACTED]

[REDACTED]

[REDACTED]

[REDACTED]

[REDACTED]

[REDACTED]

[REDACTED]

[REDACTED]

[REDACTED]

[REDACTED]

[REDACTED]

[REDACTED]

[REDACTED]

[REDACTED]

[REDACTED]

[REDACTED]. END-REDACTION

Exercise 11.5 Finite length photonic crystal.

Consider a truncated (finite length) one dimensional photonic crystal shown in fig. 11.7 below, in which there are N dielectric slabs of index n_j and length d_j . Find the transmission and reflection functions for this structure as a function of $\lambda_1, \lambda_2, a, b, g$ and β_i , where λ_1 and λ_2 are the eigenvalues of the one period matrix \mathbf{M} given in problem 3 of last week and $a, b, g,$ and β_i are also defined in the same problem.

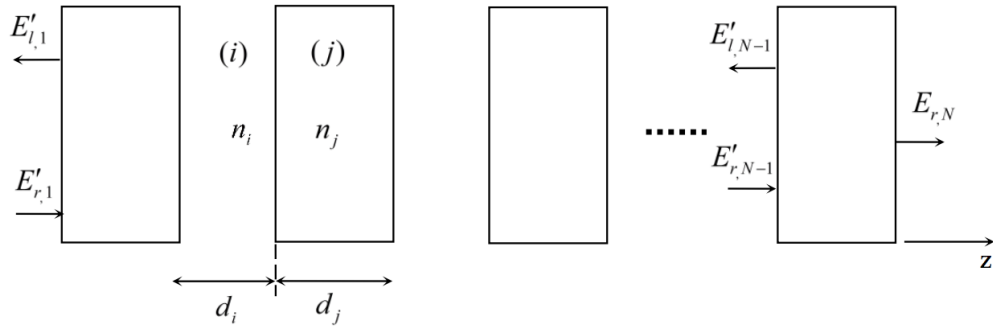

Figure 11.7: Finite photonic crystal.

Answer for Exercise 11.5

PROBLEM SET RELATED MATERIAL REDACTED IN THIS DOCUMENT. PLEASE FEEL FREE TO EMAIL ME FOR THE FULL VERSION IF YOU AREN'T TAKING ECE1228.

[REDACTED]

END-REDACTION

Exercise 11.6 Eccostock example.

Use the expression for transmission function obtained above and the values and instructions below to plot the following at normal incidence:

- Transmission magnitude and phase as a function of frequency for the case $N = 3$.
- The group delay as a function of frequency for the cases $N = 1, 2, 3, 4$.
- The group velocity as a function of frequency for the cases $N = 1, 2, 3$.
 - $n_i = 1$ (this is air), $n_j = 3.4 - j0.002$ (this is Eccostock).
 - $d_i = 1.76$ [cm]
 - $d_j = 1.33$ [cm]
 - $L_{PC} = (N - 1)(d_i + d_j) + d_j$
 - Frequency range for all plots: 20 [GHz] to 23 [GHz].

- Use linear scale for transmission magnitude (not dB) and express the transmission phase in Degrees.
- Plot the group delay in nanosecond.
- Plot the group velocity in units of V_g/c , where c is the speed of light in vacuum.

Answer for Exercise 11.6

PROBLEM SET RELATED MATERIAL REDACTED IN THIS DOCUMENT.PLEASE
FEEL FREE TO EMAIL ME FOR THE FULL VERSION IF YOU AREN'T TAKING ECE1228.

[REDACTED]

END-REDACTION

12

GAUGE FREEDOM.

12.1 PROBLEMS

Exercise 12.1 Potentials under different gauges.

Using the non-existence of magnetic monopole and Faraday's law

- a. Define the vector and scalar vector potentials $\mathbf{A}(\mathbf{r}, t)$ and $V(\mathbf{r}, t)$.
- b. Let $\mathbf{J} = \mathbf{J}_i + \mathbf{J}_c$ be the current [A/m] and ρ be the charge [C/m] densities. Assuming a simple medium and Lorentz gauge, derive the decoupled non-homogeneous wave equations for $\mathbf{A}(\mathbf{r}, t)$ and $V(\mathbf{r}, t)$.
- c. Replace the Lorentz gauge of part b with the Coulomb gauge, and obtain the non-homogeneous differential equations for $\mathbf{A}(\mathbf{r}, t)$ and $V(\mathbf{r}, t)$.
- d. What fundamental theorem allows us to use different gauges in part b and part c? (Justify your answer.)

Note: From the problem's statement, it should be clear that I want the results for the instantaneous fields and not in the form of time harmonic fields.

Answer for Exercise 12.1

PROBLEM SET RELATED MATERIAL REDACTED IN THIS DOCUMENT.PLEASE FEEL FREE TO EMAIL ME FOR THE FULL VERSION IF YOU AREN'T TAKING ECE1228.

[REDACTED]

END-REDACTION

Part II

APPENDICES

A

USEFUL FORMULAS AND REVIEW

$$\nabla' \frac{1}{R} = \frac{\hat{\mathbf{r}}}{R^2} = -\nabla \frac{1}{R} \quad (\text{A.1})$$

$$\nabla R = \hat{\mathbf{r}} = \frac{\mathbf{R}}{R} \quad (\text{A.2})$$

$$\nabla f(R) = \hat{\mathbf{r}} \frac{\partial f}{\partial R} \quad (\text{A.3})$$

$$-\nabla^2 \frac{1}{R} = 4\pi\delta(\mathbf{R}) \quad (\text{A.4})$$

$$\nabla \times \mathbf{f} = \begin{vmatrix} \mathbf{e}_1 & \mathbf{e}_2 & \mathbf{e}_3 \\ \partial/\partial x & \partial/\partial y & \partial/\partial z \\ f_x & f_y & f_z \end{vmatrix}. \quad (\text{A.5})$$

$$\nabla \times (\nabla \times \mathbf{A}) = \nabla (\nabla \cdot \mathbf{A}) - \nabla^2 \mathbf{A}. \quad (\text{A.6})$$

Proofs. This result was used in ps1 problem 3,5, and 6.

$$\begin{aligned} \nabla \times (\nabla \times \mathbf{A}) &= \epsilon_{abc} \mathbf{e}_a \partial_b (\epsilon_{rst} \mathbf{e}_r \partial_s A_t)_c \\ &= \epsilon_{abc} \mathbf{e}_a \partial_b \epsilon_{cst} \partial_s A_t \\ &= \delta_{ab}^{[st]} \mathbf{e}_a \partial_b \partial_s A_t \\ &= \mathbf{e}_a \partial_b (\partial_a A_b - \partial_b A_a) \\ &= \nabla (\nabla \cdot \mathbf{A}) - \nabla^2 \mathbf{A}. \end{aligned} \quad (\text{A.7})$$

Cylindrical coordinates

$$\begin{aligned}
\hat{\rho} &= \mathbf{e}_1 e^{i\phi} \\
\hat{\phi} &= \mathbf{e}_2 e^{i\phi} \\
\hat{\mathbf{z}} &= \mathbf{e}_3
\end{aligned} \tag{A.8}$$

$$\begin{aligned}
\partial_\phi \hat{\rho} &= \hat{\phi} \\
\partial_\phi \hat{\phi} &= -\hat{\rho}
\end{aligned} \tag{A.9}$$

$$\nabla = \hat{\rho} \partial_\rho + \frac{\hat{\phi}}{\rho} \partial_\phi + \hat{\mathbf{z}} \partial_z \tag{A.10}$$

$$\nabla \cdot \mathbf{A} = \frac{1}{\rho} \partial_\rho (\rho A_\rho) + \frac{1}{\rho} \partial_\phi A_\phi + \partial_z A_z \tag{A.11}$$

$$\nabla \times \mathbf{A} = \hat{\rho} \left(\frac{1}{\rho} \partial_\phi A_z - \partial_z A_\phi \right) + \hat{\phi} \left(\partial_z A_\rho - \partial_\rho A_z \right) + \frac{1}{\rho} \hat{\mathbf{z}} \left(\partial_\rho (\rho A_\phi) - \partial_\phi A_\rho \right) \tag{A.12}$$

$$\nabla^2 = \frac{1}{\rho} \frac{\partial}{\partial \rho} \left(\rho \frac{\partial}{\partial \rho} \right) + \frac{1}{\rho^2} \frac{\partial^2}{\partial \phi^2} + \frac{\partial^2}{\partial z^2} \tag{A.13}$$

Spherical coordinates

$$\begin{aligned}
\hat{\mathbf{r}} &= \mathbf{e}_1 e^{i\phi} \sin \theta + \mathbf{e}_3 \cos \theta \\
\hat{\theta} &= \cos \theta \mathbf{e}_1 e^{i\phi} - \sin \theta \mathbf{e}_3 \\
\hat{\phi} &= \mathbf{e}_2 e^{i\phi}
\end{aligned} \tag{A.14}$$

$$\begin{aligned}
\partial_\theta \hat{\mathbf{r}} &= \hat{\theta} \\
\partial_\phi \hat{\mathbf{r}} &= S_\theta \hat{\phi} \\
\partial_\theta \hat{\theta} &= -\hat{\mathbf{r}} \\
\partial_\phi \hat{\theta} &= C_\theta \hat{\phi} \\
\partial_\theta \hat{\phi} &= 0 \\
\partial_\phi \hat{\phi} &= -\hat{\mathbf{r}} S_\theta - \hat{\theta} C_\theta.
\end{aligned} \tag{A.15}$$

$$\nabla = \hat{\mathbf{r}} \frac{\partial}{\partial r} + \frac{\hat{\theta}}{r} \frac{\partial}{\partial \theta} + \frac{\hat{\phi}}{r \sin \theta} \frac{\partial}{\partial \phi}. \tag{A.16}$$

$$\nabla \cdot \mathbf{A} = \frac{1}{r^2} \partial_r (r^2 A_r) + \frac{1}{r S_\theta} \partial_\theta (S_\theta A_\theta) + \frac{1}{r S_\theta} \partial_\phi A_\phi. \quad (\text{A.17})$$

$$\nabla \times \mathbf{A} = \hat{\mathbf{r}} \left(\frac{1}{r S_\theta} \partial_\theta (S_\theta A_\phi) - \frac{1}{r S_\theta} \partial_\phi A_\theta \right) + \hat{\boldsymbol{\theta}} \left(\frac{1}{r S_\theta} \partial_\phi A_r - \frac{1}{r} \partial_r (r A_\phi) \right) + \hat{\boldsymbol{\phi}} \left(\frac{1}{r} \partial_r (r A_\theta) - \frac{1}{r} \partial_\theta A_r \right)$$

$$\nabla^2 \psi = \frac{1}{r^2} \frac{\partial}{\partial r} \left(r^2 \frac{\partial \psi}{\partial r} \right) + \frac{1}{r^2 \sin \theta} \frac{\partial}{\partial \theta} \left(\sin \theta \frac{\partial \psi}{\partial \theta} \right) + \frac{1}{r^2 \sin^2 \theta} \frac{\partial^2 \psi}{\partial \phi^2} \quad (\text{A.19})$$

Vector calculus. Enumerate various vc theorems (divergence, curl, the cross product version used in the BC problem, ...)

Normal and tangential decomposition. The decomposition of ?? can be derived easily using Geometric Algebra

$$\begin{aligned} \mathbf{A} &= \hat{\mathbf{n}}^2 \mathbf{A} \\ &= \hat{\mathbf{n}}(\hat{\mathbf{n}} \cdot \mathbf{A}) + \hat{\mathbf{n}}(\hat{\mathbf{n}} \wedge \mathbf{A}) \end{aligned} \quad (\text{A.20})$$

The last dot product can be expanded as a grade one (vector) selection

$$\begin{aligned} \hat{\mathbf{n}}(\hat{\mathbf{n}} \wedge \mathbf{A}) &= \langle \hat{\mathbf{n}}(\hat{\mathbf{n}} \wedge \mathbf{A}) \rangle_1 \\ &= \langle \hat{\mathbf{n}} I(\hat{\mathbf{n}} \times \mathbf{A}) \rangle_1 \\ &= I^2 \hat{\mathbf{n}} \times (\hat{\mathbf{n}} \times \mathbf{A}) \\ &= -\hat{\mathbf{n}} \times (\hat{\mathbf{n}} \times \mathbf{A}), \end{aligned} \quad (\text{A.21})$$

so the decomposition of a vector \mathbf{A} in terms of its normal and tangential projections is

$$\mathbf{A} = \hat{\mathbf{n}}(\hat{\mathbf{n}} \cdot \mathbf{A}) - \hat{\mathbf{n}} \times (\hat{\mathbf{n}} \times \mathbf{A}). \quad (\text{A.22})$$

I'm not sure how to naturally determine this relationship using traditional vector algebra. However, it can be verified by expanding the triple cross product in coordinates using tensor contraction formalism

$$\begin{aligned} -\hat{\mathbf{n}} \times (\hat{\mathbf{n}} \times \mathbf{A}) &= -\epsilon_{xyz} \mathbf{e}_x n_y (\hat{\mathbf{n}} \times \mathbf{A})_z \\ &= -\epsilon_{xyz} \mathbf{e}_x n_y \epsilon_{zrs} n_r A_s \\ &= -\delta_{xy}^{[rs]} \mathbf{e}_x n_y n_r A_s \\ &= -\mathbf{e}_x n_y (n_x A_y - n_y A_x) \\ &= -\hat{\mathbf{n}}(\hat{\mathbf{n}} \cdot \mathbf{A}) + (\hat{\mathbf{n}} \cdot \hat{\mathbf{n}}) \mathbf{A} \\ &= \mathbf{A} - \hat{\mathbf{n}}(\hat{\mathbf{n}} \cdot \mathbf{A}). \end{aligned} \quad (\text{A.23})$$

This last statement illustrates the geometry of this decomposition, showing that the tangential projection (or normal rejection) of a vector is really just the vector minus its normal projection.

B

GEOMETRIC ALGEBRA

Having used Geometric Algebra in a couple problems, it is justified to provide an overview. Further details can be found in [4], [3], [9], and [7].

Geometric Algebra defines a non-commutative, associative vector product

$$\mathbf{abc} = (\mathbf{ab})\mathbf{c} = \mathbf{a}(\mathbf{bc}), \quad (\text{B.1})$$

where the square of a vector equals the squared vector magnitude

$$\mathbf{a}^2 = |\mathbf{a}|^2, \quad (\text{B.2})$$

In Euclidean spaces such a squared vector is always positive, but that is not necessarily the case in the mixed signature spaces used in special relativity.

There are a number of consequences of these two simple vector multiplication rules.

- Squared unit vectors have a unit magnitude (up to a sign). In a Euclidean space such a product is always positive

$$(\mathbf{e}_1)^2 = 1. \quad (\text{B.3})$$

- Products of perpendicular vectors anticommute.

$$\begin{aligned} 2 &= (\mathbf{e}_1 + \mathbf{e}_2)^2 \\ &= (\mathbf{e}_1 + \mathbf{e}_2)(\mathbf{e}_1 + \mathbf{e}_2) \\ &= \mathbf{e}_1^2 + \mathbf{e}_2\mathbf{e}_1 + \mathbf{e}_1\mathbf{e}_2 + \mathbf{e}_2^2 \\ &= 2 + \mathbf{e}_2\mathbf{e}_1 + \mathbf{e}_1\mathbf{e}_2. \end{aligned} \quad (\text{B.4})$$

A product of two perpendicular vectors is called a bivector, and can be used to represent an oriented plane. The last line above shows an example of a scalar and bivector sum, called a multivector. In general Geometric Algebra allows sums of scalars, vectors, bivectors, and higher degree analogues (grades) be summed.

Comparison of the RHS and LHS of eq. (B.4) shows that we must have

$$\mathbf{e}_2\mathbf{e}_1 = -\mathbf{e}_1\mathbf{e}_2. \quad (\text{B.5})$$

It is true in general that the product of two perpendicular vectors anticommutes. When, as above, such a product is a product of two orthonormal vectors, it behaves like a non-commutative imaginary quantity, as it has an imaginary square in Euclidean spaces

$$\begin{aligned}
 (\mathbf{e}_1 \mathbf{e}_2)^2 &= (\mathbf{e}_1 \mathbf{e}_2)(\mathbf{e}_1 \mathbf{e}_2) \\
 &= \mathbf{e}_1 (\mathbf{e}_2 \mathbf{e}_1) \mathbf{e}_2 \\
 &= -\mathbf{e}_1 (\mathbf{e}_1 \mathbf{e}_2) \mathbf{e}_2 \\
 &= -(\mathbf{e}_1 \mathbf{e}_1)(\mathbf{e}_2 \mathbf{e}_2) \\
 &= -1.
 \end{aligned} \tag{B.6}$$

Such “imaginary” (unit bivectors) have important applications describing rotations in Euclidean spaces, and boosts in Minkowski spaces.

- The product of three perpendicular vectors, such as

$$I = \mathbf{e}_1 \mathbf{e}_2 \mathbf{e}_3, \tag{B.7}$$

is called a trivector. In \mathbb{R}^3 , the product of three orthonormal vectors is called a pseudoscalar for the space, and can represent an oriented volume element. The quantity I above is the typical orientation picked for the \mathbb{R}^3 unit pseudoscalar. This quantity also has characteristics of an imaginary number

$$\begin{aligned}
 I^2 &= (\mathbf{e}_1 \mathbf{e}_2 \mathbf{e}_3)(\mathbf{e}_1 \mathbf{e}_2 \mathbf{e}_3) \\
 &= \mathbf{e}_1 \mathbf{e}_2 (\mathbf{e}_3 \mathbf{e}_1) \mathbf{e}_2 \mathbf{e}_3 \\
 &= -\mathbf{e}_1 \mathbf{e}_2 \mathbf{e}_1 \mathbf{e}_3 \mathbf{e}_2 \mathbf{e}_3 \\
 &= -\mathbf{e}_1 (\mathbf{e}_2 \mathbf{e}_1) (\mathbf{e}_3 \mathbf{e}_2) \mathbf{e}_3 \\
 &= -\mathbf{e}_1 (\mathbf{e}_1 \mathbf{e}_2) (\mathbf{e}_2 \mathbf{e}_3) \mathbf{e}_3 \\
 &= -\mathbf{e}_1^2 \mathbf{e}_2^2 \mathbf{e}_3^2 \\
 &= -1.
 \end{aligned} \tag{B.8}$$

- The product of two vectors in \mathbb{R}^3 can be expressed as the sum of a symmetric scalar product and antisymmetric bivector product

$$\begin{aligned}
 \mathbf{ab} &= \sum_{i,j=1}^n \mathbf{e}_i \mathbf{e}_j a_i b_j \\
 &= \sum_{i=1}^n \mathbf{e}_i^2 a_i b_i + \sum_{0 < i \neq j \leq n} \mathbf{e}_i \mathbf{e}_j a_i b_j \\
 &= \sum_{i=1}^n a_i b_i + \sum_{0 < i < j \leq n} \mathbf{e}_i \mathbf{e}_j (a_i b_j - a_j b_i).
 \end{aligned} \tag{B.9}$$

The first (symmetric) term is clearly the dot product. The antisymmetric term is designated the wedge product. In general these are written

$$\mathbf{ab} = \mathbf{a} \cdot \mathbf{b} + \mathbf{a} \wedge \mathbf{b}, \quad (\text{B.10})$$

where

$$\begin{aligned} \mathbf{a} \cdot \mathbf{b} &\equiv \frac{1}{2} (\mathbf{ab} + \mathbf{ba}) \\ \mathbf{a} \wedge \mathbf{b} &\equiv \frac{1}{2} (\mathbf{ab} - \mathbf{ba}), \end{aligned} \quad (\text{B.11})$$

The coordinate expansion of both can be seen above, but in \mathbb{R}^3 the wedge can also be written

$$\mathbf{a} \wedge \mathbf{b} = \mathbf{e}_1 \mathbf{e}_2 \mathbf{e}_3 (\mathbf{a} \times \mathbf{b}) = I(\mathbf{a} \times \mathbf{b}). \quad (\text{B.12})$$

This allows for an handy dot plus cross product expansion of the vector product

$$\mathbf{ab} = \mathbf{a} \cdot \mathbf{b} + I(\mathbf{a} \times \mathbf{b}). \quad (\text{B.13})$$

This result should be familiar to the student of quantum spin states where one writes

$$(\boldsymbol{\sigma} \cdot \mathbf{a})(\boldsymbol{\sigma} \cdot \mathbf{b}) = (\mathbf{a} \cdot \mathbf{b}) + i(\mathbf{a} \times \mathbf{b}) \cdot \boldsymbol{\sigma}. \quad (\text{B.14})$$

This correspondence is because the Pauli spin basis is a specific matrix representation of a Geometric Algebra, satisfying the same commutator and anticommutator relationships. A number of other algebra structures, such as complex numbers, and quaterions can also be modelled as Geometric Algebra elements.

- It is often useful to utilize the grade selection operator $\langle M \rangle_n$ and scalar grade selection operator $\langle M \rangle = \langle M \rangle_0$ to select the scalar, vector, bivector, trivector, or higher grade algebraic elements. For example, operating on vectors $\mathbf{a}, \mathbf{b}, \mathbf{c}$, we have

$$\begin{aligned} \langle \mathbf{ab} \rangle &= \mathbf{a} \cdot \mathbf{b} \\ \langle \mathbf{abc} \rangle_1 &= \mathbf{a}(\mathbf{b} \cdot \mathbf{c}) + \mathbf{a} \cdot (\mathbf{b} \wedge \mathbf{c}) \\ &= \mathbf{a}(\mathbf{b} \cdot \mathbf{c}) + (\mathbf{a} \cdot \mathbf{b})\mathbf{c} - (\mathbf{a} \cdot \mathbf{c})\mathbf{b} \\ \langle \mathbf{ab} \rangle_2 &= \mathbf{a} \wedge \mathbf{b} \\ \langle \mathbf{abc} \rangle_3 &= \mathbf{a} \wedge \mathbf{b} \wedge \mathbf{c}. \end{aligned} \quad (\text{B.15})$$

Note that the wedge product of any number of vectors such as $\mathbf{a} \wedge \mathbf{b} \wedge \mathbf{c}$ is associative and can be expressed in terms of the complete antisymmetrization of the product of those vectors. A consequence of that is the fact a wedge product that includes any colinear vectors in the product is zero.

Example B.1: Helmholtz equations.

As an example of the power of eq. (B.13), consider the following Helmholtz equation derivation (wave equations for the electric and magnetic fields in the frequency domain.)

Application of eq. (B.13) to Maxwell equations in the frequency domain for source free simple media gives

$$\nabla \mathbf{E} = -j\omega I \mathbf{B} \quad (\text{B.16a})$$

$$\nabla I \mathbf{B} = -j\omega \mu \epsilon \mathbf{E}. \quad (\text{B.16b})$$

These equations use the engineering (not physics) sign convention for the phasors where the time domain fields are of the form $\mathcal{E}(\mathbf{r}, t) = \text{Re}(\mathbf{E}e^{j\omega t})$.

Operation with the gradient from the left produces the Helmholtz equation for each of the fields using nothing more than multiplication and simple substitution

$$\nabla^2 \mathbf{E} = -\mu \epsilon \omega^2 \mathbf{E} \quad (\text{B.17a})$$

$$\nabla^2 I \mathbf{B} = -\mu \epsilon \omega^2 I \mathbf{B}. \quad (\text{B.17b})$$

There was no reason to go through the headache of looking up or deriving the expansion of $\nabla \times (\nabla \times \mathbf{A})$ as is required with the traditional vector algebra demonstration of these identities.

Observe that the usual Helmholtz equation for \mathbf{B} doesn't have a pseudoscalar factor. That result can be obtained by just cancelling the factors I since the \mathbb{R}^3 Euclidean pseudoscalar commutes with all grades (this isn't the case in \mathbb{R}^2 nor in Minkowski spaces.)

Example B.2: Factoring the Laplacian.

There are various ways to demonstrate the identity

$$\nabla \times (\nabla \times \mathbf{A}) = \nabla (\nabla \cdot \mathbf{A}) - \nabla^2 \mathbf{A}, \quad (\text{B.18})$$

such as the use of (somewhat obscure) tensor contraction techniques. We can also do this with Geometric Algebra (using a different set of obscure techniques) by factoring the Laplacian action on a vector

$$\begin{aligned}
 \nabla^2 \mathbf{A} &= \nabla(\nabla \mathbf{A}) \\
 &= \nabla(\nabla \cdot \mathbf{A} + \nabla \wedge \mathbf{A}) \\
 &= \nabla(\nabla \cdot \mathbf{A}) + \nabla \cdot (\nabla \wedge \mathbf{A}) + \cancel{\nabla \wedge \nabla \wedge \mathbf{A}} \\
 &= \nabla(\nabla \cdot \mathbf{A}) + \nabla \cdot (\nabla \wedge \mathbf{A}).
 \end{aligned} \tag{B.19}$$

Should we wish to express the last term using cross products, a grade one selection operation can be used

$$\begin{aligned}
 \nabla \cdot (\nabla \wedge \mathbf{A}) &= \langle \nabla(\nabla \wedge \mathbf{A}) \rangle_1 \\
 &= \langle \nabla I(\nabla \times \mathbf{A}) \rangle_1 \\
 &= \langle I \nabla \wedge (\nabla \times \mathbf{A}) \rangle_1 \\
 &= \langle I^2 \nabla \times (\nabla \times \mathbf{A}) \rangle_1 \\
 &= -\nabla \times (\nabla \times \mathbf{A}).
 \end{aligned} \tag{B.20}$$

Here coordinate expansion was not required in any step.



JACKSON'S ELECTROSTATIC SELF ENERGY ANALYSIS

Motivation I was reading my Jackson [8], which characteristically had the statement “the [...] integral *can easily be shown* to have the value 4π ”, in a discussion of electrostatic energy and self energy. After a few attempts and a couple of pages of calculations, I figured out how this can be easily shown.

Context Let me walk through the context that leads to the “easy” integral, and then the evaluation of that integral. Unlike my older copy of Jackson, I’ll do this in SI units.

The starting point is a statement that the work done (potential energy) of one charge q_i in a set of n charges, where that charge is brought to its position \mathbf{x}_i from infinity, is

$$W_i = q_i \Phi(\mathbf{x}_i), \quad (\text{C.1})$$

where the potential energy due to the rest of the charge configuration is

$$\Phi(\mathbf{x}_i) = \frac{1}{4\pi\epsilon} \sum_{j \neq i} \frac{q_j}{|\mathbf{x}_i - \mathbf{x}_j|}. \quad (\text{C.2})$$

This means that the total potential energy, making sure not to double count, to move all the charges in from infinity is

$$W = \frac{1}{4\pi\epsilon} \sum_{1 \leq i < j \leq n} \frac{q_i q_j}{|\mathbf{x}_i - \mathbf{x}_j|}. \quad (\text{C.3})$$

This sum over all unique pairs is somewhat unwieldy, so it can be adjusted by explicitly double counting with a corresponding divide by two

$$W = \frac{1}{2} \frac{1}{4\pi\epsilon} \sum_{1 \leq i \neq j \leq n} \frac{q_i q_j}{|\mathbf{x}_i - \mathbf{x}_j|}. \quad (\text{C.4})$$

The point that causes the trouble later is the continuum equivalent to this relationship, which is

$$W = \frac{1}{8\pi\epsilon} \int \frac{\rho(\mathbf{x})\rho(\mathbf{x}')}{|\mathbf{x} - \mathbf{x}'|} d^3\mathbf{x} d^3\mathbf{x}', \quad (\text{C.5})$$

or

$$W = \frac{1}{2} \int \rho(\mathbf{x})\Phi(\mathbf{x}) d^3\mathbf{x}. \quad (\text{C.6})$$

There's a subtlety here that is often passed over. When the charge densities represent point charges $\rho(\mathbf{x}) = q\delta^3(\mathbf{x} - \mathbf{x}')$ are located at, notice that this integral equivalent is evaluated over all space, including the spaces that the charges that the charges are located at.

Ignoring that subtlety, this potential energy can be expressed in terms of the electric field, and then integrated by parts

$$\begin{aligned} W &= \frac{1}{2} \int (\nabla \cdot (\epsilon \mathbf{E})) \Phi(\mathbf{x}) d^3 \mathbf{x} \\ &= \frac{\epsilon}{2} \int (\nabla \cdot (\mathbf{E}\Phi) - (\nabla\Phi) \cdot \mathbf{E}) d^3 \mathbf{x} \\ &= \frac{\epsilon}{2} \oint dA \hat{\mathbf{n}} \cdot (\mathbf{E}\Phi) + \frac{\epsilon}{2} \int \mathbf{E} \cdot \mathbf{E} d^3 \mathbf{x}. \end{aligned} \quad (\text{C.7})$$

The presumption is that $\mathbf{E}\Phi$ falls off as the bounds of the integration volume tends to infinity. That leaves us with an energy density proportional to the square of the field

$$w = \frac{\epsilon}{2} \mathbf{E}^2. \quad (\text{C.8})$$

Inconsistency It's here that Jackson points out the inconsistency between eq. (C.8) and the original discrete analogue eq. (C.4) that this was based on. The energy density is positive definite, whereas the discrete potential energy can be negative if there is a difference in the sign of the charges.

Here Jackson uses a two particle charge distribution to help resolve this conundrum. For a superposition $\mathbf{E} = \mathbf{E}_1 + \mathbf{E}_2$, we have

$$\mathbf{E} = \frac{1}{4\pi\epsilon} \frac{q_1(\mathbf{x} - \mathbf{x}_1)}{|\mathbf{x} - \mathbf{x}_1|^3} + \frac{1}{4\pi\epsilon} \frac{q_2(\mathbf{x} - \mathbf{x}_2)}{|\mathbf{x} - \mathbf{x}_2|^3}, \quad (\text{C.9})$$

so the energy density is

$$w = \frac{1}{32\pi^2\epsilon} \frac{q_1^2}{|\mathbf{x} - \mathbf{x}_1|^4} + \frac{1}{32\pi^2\epsilon} \frac{q_2^2}{|\mathbf{x} - \mathbf{x}_2|^4} + 2 \frac{q_1 q_2}{32\pi^2\epsilon} \frac{(\mathbf{x} - \mathbf{x}_1)}{|\mathbf{x} - \mathbf{x}_1|^3} \cdot \frac{(\mathbf{x} - \mathbf{x}_2)}{|\mathbf{x} - \mathbf{x}_2|^3}. \quad (\text{C.10})$$

The discrete potential had only an interaction energy, whereas the potential from this squared field has an interaction energy plus two self energy terms. Those two strictly positive self energy terms are what forces this field energy positive, independent of the sign of the interaction energy density. Jackson makes a change of variables of the form

$$\begin{aligned} \rho &= (\mathbf{x} - \mathbf{x}_1)/R \\ R &= |\mathbf{x}_1 - \mathbf{x}_2| \\ \hat{\mathbf{n}} &= (\mathbf{x}_1 - \mathbf{x}_2)/R, \end{aligned} \quad (\text{C.11})$$

for which we find

$$\mathbf{x} = \mathbf{x}_1 + R\rho, \quad (\text{C.12})$$

so

$$\mathbf{x} - \mathbf{x}_2 = \mathbf{x}_1 - \mathbf{x}_2 + R\rho R(\hat{\mathbf{n}} + \rho), \quad (\text{C.13})$$

and

$$d^3\mathbf{x} = R^3 d^3\rho, \quad (\text{C.14})$$

so the total interaction energy is

$$\begin{aligned} W_{\text{int}} &= \frac{q_1 q_2}{16\pi^2 \epsilon} \int d^3\mathbf{x} \frac{(\mathbf{x} - \mathbf{x}_1)}{|\mathbf{x} - \mathbf{x}_1|^3} \cdot \frac{(\mathbf{x} - \mathbf{x}_2)}{|\mathbf{x} - \mathbf{x}_2|^3} \\ &= \frac{q_1 q_2}{16\pi^2 \epsilon} \int R^3 d^3\rho \frac{R\rho}{R^3 |\rho|^3} \cdot \frac{R(\hat{\mathbf{n}} + \rho)}{R^3 |\hat{\mathbf{n}} + \rho|^3} \\ &= \frac{q_1 q_2}{16\pi^2 \epsilon R} \int d^3\rho \frac{\rho}{|\rho|^3} \cdot \frac{(\hat{\mathbf{n}} + \rho)}{|\hat{\mathbf{n}} + \rho|^3}. \end{aligned} \quad (\text{C.15})$$

Evaluating this integral is what Jackson calls easy. The technique required is to express the integrand in terms of gradients in the ρ coordinate system

$$\begin{aligned} \int d^3\rho \frac{\rho}{|\rho|^3} \cdot \frac{(\hat{\mathbf{n}} + \rho)}{|\hat{\mathbf{n}} + \rho|^3} &= \int d^3\rho \left(-\nabla_\rho \frac{1}{|\rho|} \right) \cdot \left(-\nabla_\rho \frac{1}{|\hat{\mathbf{n}} + \rho|} \right) \\ &= \int d^3\rho \left(\nabla_\rho \frac{1}{|\rho|} \right) \cdot \left(\nabla_\rho \frac{1}{|\hat{\mathbf{n}} + \rho|} \right). \end{aligned} \quad (\text{C.16})$$

I found it somewhat non-trivial to find the exact form of the chain rule that is required to simplify this integral, but after some trial and error, figured it out by working backwards from

$$\nabla_\rho^2 \frac{1}{|\rho||\hat{\mathbf{n}} + \rho|} = \nabla_\rho \cdot \left(\frac{1}{|\rho|} \nabla_\rho \frac{1}{|\hat{\mathbf{n}} + \rho|} \right) + \nabla_\rho \cdot \left(\frac{1}{|\hat{\mathbf{n}} + \rho|} \nabla_\rho \frac{1}{|\rho|} \right). \quad (\text{C.17})$$

In integral form this is

$$\begin{aligned}
\oint dA' \hat{\mathbf{n}}' \cdot \nabla_{\rho} \frac{1}{|\rho||\hat{\mathbf{n}} + \rho|} &= \int d^3 \rho' \nabla_{\rho'} \cdot \left(\frac{1}{|\rho' - \hat{\mathbf{n}}|} \nabla_{\rho'} \frac{1}{|\rho'|} \right) + \int d^3 \rho \nabla_{\rho} \cdot \left(\frac{1}{|\hat{\mathbf{n}} + \rho|} \nabla_{\rho} \frac{1}{|\rho|} \right) \\
&= \int d^3 \rho' \left(\nabla_{\rho'} \frac{1}{|\rho' - \hat{\mathbf{n}}|} \cdot \nabla_{\rho'} \frac{1}{|\rho'|} \right) + \int d^3 \rho' \frac{1}{|\rho' - \hat{\mathbf{n}}|} \nabla_{\rho'}^2 \frac{1}{|\rho'|} \\
&\quad + \int d^3 \rho \left(\nabla_{\rho} \frac{1}{|\hat{\mathbf{n}} + \rho|} \right) \cdot \nabla_{\rho} \frac{1}{|\rho|} + \int d^3 \rho \frac{1}{|\hat{\mathbf{n}} + \rho|} \nabla_{\rho}^2 \frac{1}{|\rho|} \\
&= 2 \int d^3 \rho \left(\nabla_{\rho} \frac{1}{|\hat{\mathbf{n}} + \rho|} \right) \cdot \nabla_{\rho} \frac{1}{|\rho|} \\
&\quad - 4\pi \int d^3 \rho' \frac{1}{|\rho' - \hat{\mathbf{n}}|} \delta^3(\rho') - 4\pi \int d^3 \rho \frac{1}{|\rho + \hat{\mathbf{n}}|} \delta^3(\rho) \\
&= 2 \int d^3 \rho \left(\nabla_{\rho} \frac{1}{|\hat{\mathbf{n}} + \rho|} \right) \cdot \nabla_{\rho} \frac{1}{|\rho|} - 8\pi.
\end{aligned} \tag{C.18}$$

This used the Laplacian representation of the delta function $\delta^3(\mathbf{x}) = -(1/4\pi)\nabla^2(1/|\mathbf{x}|)$. Back-substitution gives

$$\int d^3 \rho \frac{\rho}{|\rho|^3} \cdot \frac{(\hat{\mathbf{n}} + \rho)}{|\hat{\mathbf{n}} + \rho|^3} = 4\pi + \oint dA' \hat{\mathbf{n}}' \cdot \nabla_{\rho} \frac{1}{|\rho||\hat{\mathbf{n}} + \rho|}. \tag{C.19}$$

We can argue that this last integral tends to zero, since

$$\begin{aligned}
\oint dA' \hat{\mathbf{n}}' \cdot \nabla_{\rho} \frac{1}{|\rho||\hat{\mathbf{n}} + \rho|} &= \oint dA' \hat{\mathbf{n}}' \cdot \left(\left(\nabla_{\rho} \frac{1}{|\rho|} \right) \frac{1}{|\hat{\mathbf{n}} + \rho|} + \frac{1}{|\rho|} \left(\nabla_{\rho} \frac{1}{|\hat{\mathbf{n}} + \rho|} \right) \right) \\
&= - \oint dA' \hat{\mathbf{n}}' \cdot \left(\frac{\rho}{|\rho|^3} \frac{1}{|\hat{\mathbf{n}} + \rho|} + \frac{1}{|\rho|} \frac{(\rho + \hat{\mathbf{n}})}{|\hat{\mathbf{n}} + \rho|^3} \right) \\
&= - \oint dA' \frac{1}{|\rho||\rho + \hat{\mathbf{n}}|} \left(\frac{\hat{\mathbf{n}}' \cdot \rho}{|\rho|^2} + \frac{\hat{\mathbf{n}}' \cdot (\rho + \hat{\mathbf{n}})}{|\rho + \hat{\mathbf{n}}|^2} \right).
\end{aligned} \tag{C.20}$$

The integrand in this surface integral is of $O(1/\rho^3)$ so tends to zero on an infinite surface in the ρ coordinate system. This completes the “easy” integral, leaving

$$\int d^3 \rho \frac{\rho}{|\rho|^3} \cdot \frac{(\hat{\mathbf{n}} + \rho)}{|\hat{\mathbf{n}} + \rho|^3} = 4\pi. \tag{C.21}$$

The total field energy can now be expressed as a sum of the self energies and the interaction energy

$$W = \frac{1}{32\pi^2\epsilon} \int d^3 \mathbf{x} \frac{q_1^2}{|\mathbf{x} - \mathbf{x}_1|^4} + \frac{1}{32\pi^2\epsilon} \int d^3 \mathbf{x} \frac{q_2^2}{|\mathbf{x} - \mathbf{x}_2|^4} + \frac{1}{4\pi\epsilon} \frac{q_1 q_2}{|\mathbf{x}_1 - \mathbf{x}_2|}. \tag{C.22}$$

The interaction energy is exactly the potential energies for the two particles, the this total energy in the field is biased in the positive direction by the pair of self energies. It is interesting that the energy obtained from integrating the field energy density contains such self energy terms, but I don't know exactly what to make of them at this point in time.

D

MAGNETOSTATIC FORCE AND TORQUE.

In Jackson [8], the following equations for the vector potential, magnetostatic force and torque are derived

$$\mathbf{m} = \frac{1}{2} \int \mathbf{x}' \times \mathbf{J}(\mathbf{x}') d^3 x' \quad (\text{D.1})$$

$$\mathbf{F} = \nabla(\mathbf{m} \cdot \mathbf{B}), \quad (\text{D.2})$$

$$\mathbf{N} = \mathbf{m} \times \mathbf{B}, \quad (\text{D.3})$$

where \mathbf{B} is an applied external magnetic field and \mathbf{m} is the magnetic dipole for the current in question. These results (and a similar one derived earlier for the vector potential \mathbf{A}) all follow from an analysis of localized current densities \mathbf{J} , evaluated far enough away from the current sources.

For the force and torque, the starting point for the force is one that had me puzzled a bit. Namely

$$\mathbf{F} = \int \mathbf{J}(\mathbf{x}) \times \mathbf{B}(\mathbf{x}) d^3 x \quad (\text{D.4})$$

This is clearly the continuum generalization of the point particle Lorentz force equation, which for $\mathbf{E} = 0$ is:

$$\mathbf{F} = q\mathbf{v} \times \mathbf{B} \quad (\text{D.5})$$

For the point particle, this is the force on the particle when it is in the external field \mathbf{B} . i.e. this is the force at the position of the particle. My question is what does it mean to sum all the forces on the charge distribution over all space. How can a force be applied over all, as opposed to a force applied at a single point, or against a surface?

In the special case of a localized current density, this makes some sense. Considering the other half of the force equation $\mathbf{F} = \frac{d}{dt} \int \rho_m \mathbf{v} dV$, where ρ_m here is mass density of the charged particles making up the continuous current distribution. The other half of this $\mathbf{F} = m\mathbf{a}$ equation is also an average phenomena, so we have an average of sorts on both the field contribution to the force equation and the mass contribution to the force equation. There is probably a centre-of-mass and centre-of-current density interpretation that would make a bit more sense of this continuum force description.

It's kind of funny how you can work through all the detailed mathematical steps in a book like Jackson, but then go right back to the beginning and say "Hey, what does that even mean"?

Force Moving on from the pondering of the meaning of the equation being manipulated, let's do the easy part, the derivation of the results that Jackson comes up with.

Writing out eq. (D.4) in coordinates

$$\mathbf{F} = \epsilon_{ijk} \mathbf{e}_i \int J_j B_k d^3 x. \quad (\text{D.6})$$

To first order, a slowly varying (external) magnetic field can be expanded around a point of interest

$$\mathbf{B}(\mathbf{x}) = \mathbf{B}(\mathbf{x}_0) + (\mathbf{x} - \mathbf{x}_0) \cdot \nabla \mathbf{B}, \quad (\text{D.7})$$

where the directional derivative is evaluated at the point \mathbf{x}_0 after the gradient operation. Setting the origin at this point \mathbf{x}_0 gives

$$\begin{aligned} \mathbf{F} &= \epsilon_{ijk} \mathbf{e}_i \left(\int J_j(\mathbf{x}') B_k(0) d^3 x' + \int J_j(\mathbf{x}') (\mathbf{x}' \cdot \nabla) B_k(0) d^3 x' \right) \\ &= \epsilon_{ijk} \mathbf{e}_i \mathbf{k}_0 \int J_j(\mathbf{x}') d^3 x' + \epsilon_{ijk} \mathbf{e}_i \int J_j(\mathbf{x}') (\mathbf{x}' \cdot \nabla) B_k(0) d^3 x'. \end{aligned} \quad (\text{D.8})$$

We found in ?? that the first integral can be written as a divergence

$$\int J_j(\mathbf{x}') d^3 x' = \int \nabla' \cdot (\mathbf{J}(\mathbf{x}') x'_j) dV', \quad (\text{D.9})$$

which is zero when the integration surface is outside of the current localization region. We also found in ?? that

$$\int (\mathbf{x} \cdot \mathbf{x}') \mathbf{J} = -\frac{1}{2} \mathbf{x} \times \int \mathbf{x}' \times \mathbf{J} = \mathbf{m} \times \mathbf{x}. \quad (\text{D.10})$$

so

$$\begin{aligned} \int (\nabla B_k(0) \cdot \mathbf{x}') J_j &= -\frac{1}{2} \left(\nabla B_k(0) \times \int \mathbf{x}' \times \mathbf{J} \right)_j \\ &= (\mathbf{m} \times (\nabla B_k(0)))_j. \end{aligned} \quad (\text{D.11})$$

This gives

$$\begin{aligned} \mathbf{F} &= \epsilon_{ijk} \mathbf{e}_i (\mathbf{m} \times (\nabla B_k(0)))_j \\ &= \epsilon_{ijk} \mathbf{e}_i (\mathbf{m} \times \nabla)_j B_k(0) \\ &= (\mathbf{m} \times \nabla) \times \mathbf{B}(0) \\ &= -\mathbf{B}(0) \times (\mathbf{m} \times \overleftarrow{\nabla}) \\ &= (\mathbf{B}(0) \cdot \mathbf{m}) \overleftarrow{\nabla} - (\mathbf{B} \cdot \overleftarrow{\nabla}) \mathbf{m} \\ &= \nabla(\mathbf{B}(0) \cdot \mathbf{m}) - \mathbf{m}(\nabla \cdot \mathbf{B}(0)). \end{aligned} \quad (\text{D.12})$$

The second term is killed by the magnetic Gauss's law, leaving to first order

$$\mathbf{F} = \nabla(\mathbf{m} \cdot \mathbf{B}). \quad (\text{D.13})$$

Torque For the torque we have a similar quandary at the starting point. About what point is a continuum torque integral of the following form

$$\mathbf{N} = \int \mathbf{x}' \times (\mathbf{J}(\mathbf{x}') \times \mathbf{B}(\mathbf{x}')) d^3 x' \quad (\text{D.14})$$

Ignoring that detail again, assuming the answer has something to do with the centre of mass and parallel axis theorem, we can proceed with a constant approximation of the magnetic field

$$\begin{aligned} \mathbf{N} &= \int \mathbf{x}' \times (\mathbf{J}(\mathbf{x}') \times \mathbf{B}(0)) d^3 x' \\ &= - \int (\mathbf{x}' \cdot \mathbf{J}(\mathbf{x}')) \mathbf{B}(0) d^3 x' + \int (\mathbf{x}' \cdot \mathbf{B}(0)) \mathbf{J}(\mathbf{x}') d^3 x' \\ &= -\mathbf{B}(0) \int (\mathbf{x}' \cdot \mathbf{J}(\mathbf{x}')) d^3 x' + \int (\mathbf{x}' \cdot \mathbf{B}(0)) \mathbf{J}(\mathbf{x}') d^3 x'. \end{aligned} \quad (\text{D.15})$$

Jackson's trick for killing the first integral is to transform it into a divergence by evaluating

$$\begin{aligned} \nabla \cdot (\mathbf{J}|\mathbf{x}|^2) &= (\nabla \cdot \mathbf{J})|\mathbf{x}|^2 + \mathbf{J} \cdot \nabla |\mathbf{x}|^2 \\ &= \mathbf{J} \cdot \mathbf{e}_i \partial_i x_m x_m \\ &= 2\mathbf{J} \cdot \mathbf{e}_i \delta_{im} x_m \\ &= 2\mathbf{J} \cdot \mathbf{x}, \end{aligned} \quad (\text{D.16})$$

so

$$\begin{aligned} \mathbf{N} &= -\frac{1}{2} \mathbf{B}(0) \int \nabla' \cdot (\mathbf{J}(\mathbf{x}') |\mathbf{x}'|^2) d^3 x' + \int (\mathbf{x}' \cdot \mathbf{B}(0)) \mathbf{J}(\mathbf{x}') d^3 x' \\ &= -\frac{1}{2} \mathbf{B}(0) \oint \mathbf{n} \cdot (\mathbf{J}(\mathbf{x}') |\mathbf{x}'|^2) d^3 x' + \int (\mathbf{x}' \cdot \mathbf{B}(0)) \mathbf{J}(\mathbf{x}') d^3 x'. \end{aligned} \quad (\text{D.17})$$

Again, the localized current density assumption kills the surface integral. The second integral can be evaluated with eq. (D.10), so to first order we have

$$\mathbf{N} = \mathbf{m} \times \mathbf{B}. \quad (\text{D.18})$$

E

LINE CHARGE FIELD AND POTENTIAL

When computing the most general solution of the electrostatic potential in a plane, Jackson [8] mentions that $-2\lambda_0 \ln \rho$ is the well known potential for an infinite line charge (up to the unit specific factor). Checking that statement, since I didn't recall what that potential was offhand, I encountered some inconsistencies and non-convergent integrals, and thought it was worthwhile to explore those a bit more carefully. This will be done here.

Using Gauss's law. For an infinite length line charge, we can find the radial field contribution using Gauss's law, imagining a cylinder of length Δl of radius ρ surrounding this charge with the midpoint at the origin. Ignoring any non-radial field contribution, we have

$$\int_{-\Delta l/2}^{\Delta l/2} \hat{\mathbf{n}} \cdot \mathbf{E}(2\pi\rho)dl = \frac{\lambda_0}{\epsilon_0}\Delta l, \quad (\text{E.1})$$

or

$$\mathbf{E} = \frac{\lambda_0}{2\pi\epsilon_0} \frac{\hat{\rho}}{\rho}. \quad (\text{E.2})$$

Since

$$\frac{\hat{\rho}}{\rho} = \nabla \ln \rho, \quad (\text{E.3})$$

this means that the potential is

$$\phi = -\frac{2\lambda_0}{4\pi\epsilon_0} \ln \rho. \quad (\text{E.4})$$

Finite line charge potential. Let's try both these calculations for a finite charge distribution. Gauss's law loses its usefulness, but we can evaluate the integrals directly. For the electric field

$$\mathbf{E} = \frac{\lambda_0}{4\pi\epsilon_0} \int \frac{(\mathbf{x} - \mathbf{x}')}{|\mathbf{x} - \mathbf{x}'|^3} dl'. \quad (\text{E.5})$$

Using cylindrical coordinates with the field point $\mathbf{x} = \rho\hat{\rho}$ for convenience, the charge point $\mathbf{x}' = z'\hat{\mathbf{z}}$, and a the charge distributed over $[a, b]$ this is

$$\mathbf{E} = \frac{\lambda_0}{4\pi\epsilon_0} \int_a^b \frac{(\rho\hat{\rho} - z'\hat{\mathbf{z}})}{(\rho^2 + (z')^2)^{3/2}} dz'. \quad (\text{E.6})$$

When the charge is uniformly distributed around the origin $[a, b] = b[-1, 1]$ the $\hat{\mathbf{z}}$ component of this field is killed because the integrand is odd. This justifies ignoring such contributions in the Gaussian cylinder analysis above. The general solution to this integral is found to be

$$\mathbf{E} = \frac{\lambda_0}{4\pi\epsilon_0} \left(\frac{z'\hat{\boldsymbol{\rho}}}{\rho\sqrt{\rho^2 + (z')^2}} + \frac{\hat{\mathbf{z}}}{\sqrt{\rho^2 + (z')^2}} \right) \Bigg|_a^b, \quad (\text{E.7})$$

or

$$\mathbf{E} = \frac{\lambda_0}{4\pi\epsilon_0} \left(\frac{\hat{\boldsymbol{\rho}}}{\rho} \left(\frac{b}{\sqrt{\rho^2 + b^2}} - \frac{a}{\sqrt{\rho^2 + a^2}} \right) + \hat{\mathbf{z}} \left(\frac{1}{\sqrt{\rho^2 + b^2}} - \frac{1}{\sqrt{\rho^2 + a^2}} \right) \right). \quad (\text{E.8})$$

When $b = -a = \Delta l/2$, this reduces to

$$\mathbf{E} = \frac{\lambda_0}{4\pi\epsilon_0} \frac{\hat{\boldsymbol{\rho}}}{\rho} \frac{\Delta l}{\sqrt{\rho^2 + (\Delta l/2)^2}}, \quad (\text{E.9})$$

which further reduces to eq. (E.2) when $\Delta l \gg \rho$.

Finite line charge potential. Wrong but illuminating. Again, putting the field point at $z' = 0$, we have

$$\phi(\rho) = \frac{\lambda_0}{4\pi\epsilon_0} \int_a^b \frac{dz'}{(\rho^2 + (z')^2)^{1/2}}, \quad (\text{E.10})$$

which integrates to

$$\phi(\rho) = \frac{\lambda_0}{4\pi\epsilon_0} \ln \frac{b + \sqrt{\rho^2 + b^2}}{a + \sqrt{\rho^2 + a^2}}. \quad (\text{E.11})$$

With $b = -a = \Delta l/2$, this approaches

$$\begin{aligned} \phi &\approx \frac{\lambda_0}{4\pi\epsilon_0} \ln \frac{(\Delta l/2)}{\rho^2/2|\Delta l/2|} \\ &= \frac{-2\lambda_0}{4\pi\epsilon_0} \ln \rho + \frac{\lambda_0}{4\pi\epsilon_0} \ln((\Delta l)^2/2). \end{aligned} \quad (\text{E.12})$$

Before Δl is allowed to tend to infinity, this is identical (up to a difference in the reference potential) to eq. (E.4) found using Gauss's law. It is, strictly speaking, singular when $\Delta l \rightarrow \infty$, so it does not seem right to infinity as a reference point for the potential.

There's another weird thing about this result. Since this has no z dependence, it is not obvious how we would recover the non-radial portion of the electric field from this potential using $\mathbf{E} = -\nabla\phi$? Let's calculate the electric field from eq. (E.10) explicitly

$$\begin{aligned}
 \mathbf{E} &= -\frac{\lambda_0}{4\pi\epsilon_0} \nabla \ln \frac{b + \sqrt{\rho^2 + b^2}}{a + \sqrt{\rho^2 + a^2}} \\
 &= -\frac{\lambda_0 \hat{\rho}}{4\pi\epsilon_0} \frac{\partial}{\partial \rho} \ln \frac{b + \sqrt{\rho^2 + b^2}}{a + \sqrt{\rho^2 + a^2}} \\
 &= -\frac{\lambda_0 \hat{\rho}}{4\pi\epsilon_0} \left(\frac{1}{b + \sqrt{\rho^2 + b^2}} \frac{\rho}{\sqrt{\rho^2 + b^2}} - \frac{1}{a + \sqrt{\rho^2 + a^2}} \frac{\rho}{\sqrt{\rho^2 + a^2}} \right) \\
 &= -\frac{\lambda_0 \hat{\rho}}{4\pi\epsilon_0 \rho} \left(\frac{-b + \sqrt{\rho^2 + b^2}}{\sqrt{\rho^2 + b^2}} - \frac{-a + \sqrt{\rho^2 + a^2}}{\sqrt{\rho^2 + a^2}} \right) \\
 &= \frac{\lambda_0 \hat{\rho}}{4\pi\epsilon_0 \rho} \left(\frac{b}{\sqrt{\rho^2 + b^2}} - \frac{a}{\sqrt{\rho^2 + a^2}} \right).
 \end{aligned} \tag{E.13}$$

This recovers the radial component of the field from eq. (E.8), but where did the \hat{z} component go? The required potential appears to be

$$\phi(\rho, z) = \frac{\lambda_0}{4\pi\epsilon_0} \ln \frac{b + \sqrt{\rho^2 + b^2}}{a + \sqrt{\rho^2 + a^2}} - \frac{z\lambda_0}{4\pi\epsilon_0} \left(\frac{1}{\sqrt{\rho^2 + b^2}} - \frac{1}{\sqrt{\rho^2 + a^2}} \right). \tag{E.14}$$

When computing the electric field $\mathbf{E}(\rho, \theta, z)$, it was convenient to pick the coordinate system so that $z = 0$. Doing this with the potential gives the wrong answers. The reason for this appears to be that this kills the potential term that is linear in z before taking its gradient, and we need that term to have the \hat{z} field component that is expected for a charge distribution that is non-symmetric about the origin on the z -axis!

Finite line charge potential. Take II. Let the point at which the potential is evaluated be

$$\mathbf{x} = \rho \hat{\rho} + z \hat{z}, \tag{E.15}$$

and the charge point be

$$\mathbf{x}' = z' \hat{z}. \tag{E.16}$$

This gives

$$\begin{aligned}
\phi(\rho, z) &= \frac{\lambda_0}{4\pi\epsilon_0} \int_a^b \frac{dz'}{|\rho^2 + (z - z')^2|} \\
&= \frac{\lambda_0}{4\pi\epsilon_0} \int_{a-z}^{b-z} \frac{du}{|\rho^2 + u^2|} \\
&= \frac{\lambda_0}{4\pi\epsilon_0} \ln \left(u + \sqrt{\rho^2 + u^2} \right) \Big|_{b-z}^{a-z} \\
&= \frac{\lambda_0}{4\pi\epsilon_0} \ln \frac{b - z + \sqrt{\rho^2 + (b - z)^2}}{a - z + \sqrt{\rho^2 + (a - z)^2}}.
\end{aligned} \tag{E.17}$$

The limit of this potential $a = -\Delta/2 \rightarrow -\infty, b = \Delta/2 \rightarrow \infty$ doesn't exist in any strict sense. If we are cavalier about the limits, as in eq. (E.12), this can be evaluated as

$$\phi \approx \frac{\lambda_0}{4\pi\epsilon_0} (-2 \ln \rho + \text{constant}). \tag{E.18}$$

however, the constant ($\ln \Delta^2/2$) is infinite, so there isn't really a good justification for using that constant as the potential reference point directly.

It seems that the “right” way to calculate the potential for the infinite distribution, is to

- Calculate the field from the potential.
- Take the PV limit of that field with the charge distribution extending to infinity.
- Compute the corresponding potential from this limiting value of the field.

Doing that doesn't blow up. That field calculation, for the finite case, should include a \hat{z} component. To verify, let's take the respective derivatives

$$\begin{aligned}
-\frac{\partial}{\partial z} \phi &= -\frac{\lambda_0}{4\pi\epsilon_0} \left(\frac{-1 + \frac{z-b}{\sqrt{\rho^2 + (b-z)^2}}}{b-z + \sqrt{\rho^2 + (b-z)^2}} - \frac{-1 + \frac{z-a}{\sqrt{\rho^2 + (a-z)^2}}}{a-z + \sqrt{\rho^2 + (a-z)^2}} \right) \\
&= \frac{\lambda_0}{4\pi\epsilon_0} \left(\frac{1 + \frac{b-z}{\sqrt{\rho^2 + (b-z)^2}}}{b-z + \sqrt{\rho^2 + (b-z)^2}} - \frac{1 + \frac{a-z}{\sqrt{\rho^2 + (a-z)^2}}}{a-z + \sqrt{\rho^2 + (a-z)^2}} \right) \\
&= \frac{\lambda_0}{4\pi\epsilon_0} \left(\frac{1}{\sqrt{\rho^2 + (b-z)^2}} - \frac{1}{\sqrt{\rho^2 + (a-z)^2}} \right),
\end{aligned} \tag{E.19}$$

and

$$\begin{aligned}
 -\frac{\partial}{\partial \rho} \phi &= -\frac{\lambda_0}{4\pi\epsilon_0} \left(\frac{\frac{\rho}{\sqrt{\rho^2 + (b-z)^2}}}{b-z + \sqrt{\rho^2 + (b-z)^2}} - \frac{\frac{\rho}{\sqrt{\rho^2 + (a-z)^2}}}{a-z + \sqrt{\rho^2 + (a-z)^2}} \right) \\
 &= -\frac{\lambda_0}{4\pi\epsilon_0} \left(\frac{\rho \left(-(b-z) + \sqrt{\rho^2 + (b-z)^2} \right)}{\rho^2 \sqrt{\rho^2 + (b-z)^2}} - \frac{\rho \left(-(a-z) + \sqrt{\rho^2 + (a-z)^2} \right)}{\rho^2 \sqrt{\rho^2 + (a-z)^2}} \right) \quad (\text{E.20}) \\
 &= \frac{\lambda_0}{4\pi\epsilon_0 \rho} \left(\frac{b-z}{\sqrt{\rho^2 + (b-z)^2}} - \frac{a-z}{\sqrt{\rho^2 + (a-z)^2}} \right).
 \end{aligned}$$

Putting the pieces together, the electric field is

$$\mathbf{E} = \frac{\lambda_0}{4\pi\epsilon_0} \left(\frac{\hat{\rho}}{\rho} \left(\frac{b-z}{\sqrt{\rho^2 + (b-z)^2}} - \frac{a-z}{\sqrt{\rho^2 + (a-z)^2}} \right) + \hat{\mathbf{z}} \left(\frac{1}{\sqrt{\rho^2 + (b-z)^2}} - \frac{1}{\sqrt{\rho^2 + (a-z)^2}} \right) \right). \quad (\text{E.21})$$

This has a PV limit of eq. (E.2) at $z = 0$, and also for the finite case, has the $\hat{\mathbf{z}}$ field component that was obtained when the field was obtained by direct integration.

Conclusions

- We have to evaluate the potential at all points in space, not just on the axis that we evaluate the field on (should we choose to do so).
- In this case, we found that it was not directly meaningful to take the limit of a potential distribution. We can, however, compute the field from a potential for a finite charge distribution, take the limit of that field, and then calculate the corresponding potential for the infinite distribution.

Is there a more robust mechanism that can be used to directly calculate the potential for an infinite charge distribution, instead of calculating the potential from the field of such an infinite distribution?

I think that where things go wrong is that the integral of eq. (E.10) does not apply to charge distributions that are not finite on the infinite range $z \in [-\infty, \infty]$. That solution was obtained by utilizing an all-space Green's function, and the boundary term in that Green's analysis was assumed to tend to zero. That isn't the case when the charge distribution is $\lambda_0 \delta(z)$.

F

GRADIENT, DIVERGENCE, CURL AND LAPLACIAN IN CYLINDRICAL COORDINATES.

In class it was suggested that the identity

$$\nabla^2 \mathbf{A} = \nabla(\nabla \cdot \mathbf{A}) - \nabla \times (\nabla \times \mathbf{A}), \quad (\text{F.1})$$

can be used to compute the Laplacian in non-rectangular coordinates. Is that the easiest way to do this?

How about just sequential applications of the gradient on the vector? Let's start with the vector product of the gradient and the vector. First recall that the cylindrical representation of the gradient is

$$\nabla = \hat{\rho} \partial_\rho + \frac{\hat{\phi}}{\rho} \partial_\phi + \hat{z} \partial_z, \quad (\text{F.2})$$

where

$$\begin{aligned} \hat{\rho} &= \mathbf{e}_1 e^{\mathbf{e}_1 \mathbf{e}_2 \phi} \\ \hat{\phi} &= \mathbf{e}_2 e^{\mathbf{e}_1 \mathbf{e}_2 \phi} \end{aligned} \quad (\text{F.3})$$

Taking ϕ derivatives of eq. (F.3), we have

$$\begin{aligned} \partial_\phi \hat{\rho} &= \mathbf{e}_1 \mathbf{e}_1 \mathbf{e}_2 e^{\mathbf{e}_1 \mathbf{e}_2 \phi} = \mathbf{e}_2 e^{\mathbf{e}_1 \mathbf{e}_2 \phi} = \hat{\phi} \\ \partial_\phi \hat{\phi} &= \mathbf{e}_2 \mathbf{e}_1 \mathbf{e}_2 e^{\mathbf{e}_1 \mathbf{e}_2 \phi} = -\mathbf{e}_1 e^{\mathbf{e}_1 \mathbf{e}_2 \phi} = -\hat{\rho}. \end{aligned} \quad (\text{F.4})$$

The gradient of a vector $\mathbf{A} = \hat{\rho} A_\rho + \hat{\phi} A_\phi + \hat{z} A_z$ is

$$\begin{aligned}
\nabla \mathbf{A} &= \left(\hat{\rho} \partial_\rho + \frac{\hat{\phi}}{\rho} \partial_\phi + \hat{z} \partial_z \right) (\hat{\rho} A_\rho + \hat{\phi} A_\phi + \hat{z} A_z) \\
&= \hat{\rho} \partial_\rho (\hat{\rho} A_\rho + \hat{\phi} A_\phi + \hat{z} A_z) \\
&\quad + \frac{\hat{\phi}}{\rho} \partial_\phi (\hat{\rho} A_\rho + \hat{\phi} A_\phi + \hat{z} A_z) \\
&\quad + \hat{z} \partial_z (\hat{\rho} A_\rho + \hat{\phi} A_\phi + \hat{z} A_z) \\
&= \hat{\rho} (\hat{\rho} \partial_\rho A_\rho + \hat{\phi} \partial_\rho A_\phi + \hat{z} \partial_\rho A_z) \\
&\quad + \frac{\hat{\phi}}{\rho} (\partial_\phi (\hat{\rho} A_\rho) + \partial_\phi (\hat{\phi} A_\phi) + \hat{z} \partial_\phi A_z) \\
&\quad + \hat{z} (\hat{\rho} \partial_z A_\rho + \hat{\phi} \partial_z A_\phi + \hat{z} \partial_z A_z) \\
&= \partial_\rho A_\rho + \hat{\rho} \hat{\phi} \partial_\rho A_\phi + \hat{\rho} \hat{z} \partial_\rho A_z \\
&\quad + \frac{1}{\rho} (A_\rho + \hat{\phi} \hat{\rho} \partial_\phi A_\rho - \hat{\phi} \hat{\rho} A_\phi + \partial_\phi A_\phi + \hat{\phi} \hat{z} \partial_\phi A_z) \\
&\quad + \hat{z} \hat{\rho} \partial_z A_\rho + \hat{z} \hat{\phi} \partial_z A_\phi + \partial_z A_z \\
&= \partial_\rho A_\rho + \frac{1}{\rho} (A_\rho + \partial_\phi A_\phi) + \partial_z A_z \\
&\quad + \hat{z} \hat{\rho} (\partial_z A_\rho - \partial_\rho A_z) \\
&\quad + \hat{\phi} \hat{z} \left(\frac{1}{\rho} \partial_\phi A_z - \partial_z A_\phi \right) \\
&\quad + \hat{\rho} \hat{\phi} \left(\partial_\rho A_\phi - \frac{1}{\rho} (\partial_\phi A_\rho - A_\phi) \right),
\end{aligned} \tag{F.5}$$

As expected, we see that the gradient splits nicely into a dot and curl

$$\nabla \mathbf{A} = \nabla \cdot \mathbf{A} + \nabla \wedge \mathbf{A} = \nabla \cdot \mathbf{A} + \hat{\rho} \hat{\phi} \hat{z} (\nabla \times \mathbf{A}), \tag{F.6}$$

where the cylindrical representation of the divergence is seen to be

$$\nabla \cdot \mathbf{A} = \frac{1}{\rho} \partial_\rho (\rho A_\rho) + \frac{1}{\rho} \partial_\phi A_\phi + \partial_z A_z, \tag{F.7}$$

and the cylindrical representation of the curl is

$$\nabla \times \mathbf{A} = \hat{\rho} \left(\frac{1}{\rho} \partial_\phi A_z - \partial_z A_\phi \right) + \hat{\phi} (\partial_z A_\rho - \partial_\rho A_z) + \frac{1}{\rho} \hat{z} (\partial_\rho (\rho A_\phi) - \partial_\phi A_\rho). \tag{F.8}$$

Should we want to, it is now possible to evaluate the Laplacian of \mathbf{A} using eq. (F.1), which will have the following components

$$\begin{aligned}
\hat{\rho} \cdot (\nabla^2 \mathbf{A}) &= \partial_\rho \left(\frac{1}{\rho} \partial_\rho (\rho A_\rho) + \frac{1}{\rho} \partial_\phi A_\phi + \partial_z A_z \right) - \left(\frac{1}{\rho} \partial_\phi \left(\frac{1}{\rho} (\partial_\rho (\rho A_\phi) - \partial_\phi A_\rho) \right) - \partial_z (\partial_z A_\rho - \partial_\rho A_z) \right) \\
&= \partial_\rho \left(\frac{1}{\rho} \partial_\rho (\rho A_\rho) \right) + \partial_\rho \left(\frac{1}{\rho} \partial_\phi A_\phi \right) + \partial_{\rho z} A_z - \frac{1}{\rho^2} \partial_{\phi \rho} (\rho A_\phi) + \frac{1}{\rho^2} \partial_{\phi \phi} A_\rho + \partial_{zz} A_\rho - \partial_{z\rho} A_z \\
&= \partial_\rho \left(\frac{1}{\rho} \partial_\rho (\rho A_\rho) \right) + \frac{1}{\rho^2} \partial_{\phi \phi} A_\rho + \partial_{zz} A_\rho - \frac{1}{\rho^2} \partial_{\phi A_\phi} + \frac{1}{\rho} \partial_{\rho \phi} A_\phi - \frac{1}{\rho^2} \partial_{\phi A_\phi} - \frac{1}{\rho} \partial_{\phi \rho} A_\phi \\
&= \partial_\rho \left(\frac{1}{\rho} \partial_\rho (\rho A_\rho) \right) + \frac{1}{\rho^2} \partial_{\phi \phi} A_\rho + \partial_{zz} A_\rho - \frac{2}{\rho^2} \partial_{\phi A_\phi} \\
&= \frac{1}{\rho} \partial_\rho (\rho \partial_\rho A_\rho) + \frac{1}{\rho^2} \partial_{\phi \phi} A_\rho + \partial_{zz} A_\rho - \frac{A_\rho}{\rho^2} - \frac{2}{\rho^2} \partial_{\phi A_\phi},
\end{aligned} \tag{F.9a}$$

$$\begin{aligned}
\hat{\phi} \cdot (\nabla^2 \mathbf{A}) &= \frac{1}{\rho} \partial_\phi \left(\frac{1}{\rho} \partial_\rho (\rho A_\rho) + \frac{1}{\rho} \partial_\phi A_\phi + \partial_z A_z \right) - \left(\left(\partial_z \left(\frac{1}{\rho} \partial_\phi A_z - \partial_z A_\phi \right) - \partial_\rho \left(\frac{1}{\rho} (\partial_\rho (\rho A_\phi) - \partial_\phi A_\rho) \right) \right) \right) \\
&= \frac{1}{\rho^2} \partial_{\phi \rho} (\rho A_\rho) + \frac{1}{\rho^2} \partial_{\phi \phi} A_\phi + \frac{1}{\rho} \partial_{\phi z} A_z - \frac{1}{\rho} \partial_{z\phi} A_z + \partial_{zz} A_\phi + \partial_\rho \left(\frac{1}{\rho} \partial_\rho (\rho A_\phi) \right) - \partial_\rho \left(\frac{1}{\rho} \partial_\phi A_\rho \right) \\
&= \partial_\rho \left(\frac{1}{\rho} \partial_\rho (\rho A_\phi) \right) + \frac{1}{\rho^2} \partial_{\phi \phi} A_\phi + \partial_{zz} A_\phi + \frac{1}{\rho^2} \partial_{\phi \rho} (\rho A_\rho) + \frac{1}{\rho} \partial_{\phi z} A_z - \frac{1}{\rho} \partial_{z\phi} A_z - \partial_\rho \left(\frac{1}{\rho} \partial_\phi A_\rho \right) \\
&= \partial_\rho \left(\frac{1}{\rho} \partial_\rho (\rho A_\phi) \right) + \frac{1}{\rho^2} \partial_{\phi \phi} A_\phi + \partial_{zz} A_\phi + \frac{1}{\rho^2} \partial_{\phi A_\rho} + \frac{1}{\rho} \partial_{\phi \rho} A_\rho + \frac{1}{\rho^2} \partial_{\phi A_\rho} - \frac{1}{\rho} \partial_{\rho \phi} A_\rho \\
&= \partial_\rho \left(\frac{1}{\rho} \partial_\rho (\rho A_\phi) \right) + \frac{1}{\rho^2} \partial_{\phi \phi} A_\phi + \partial_{zz} A_\phi + \frac{2}{\rho^2} \partial_{\phi A_\rho} \\
&= \frac{1}{\rho} \partial_\rho (\rho \partial_\rho A_\phi) + \frac{1}{\rho^2} \partial_{\phi \phi} A_\phi + \partial_{zz} A_\phi + \frac{2}{\rho^2} \partial_{\phi A_\rho} - \frac{A_\phi}{\rho^2},
\end{aligned} \tag{F.9b}$$

$$\begin{aligned}
\hat{z} \cdot (\nabla^2 \mathbf{A}) &= \partial_z \left(\frac{1}{\rho} \partial_\rho (\rho A_\rho) + \frac{1}{\rho} \partial_\phi A_\phi + \partial_z A_z \right) - \frac{1}{\rho} \left(\partial_\rho (\rho (\partial_z A_\rho - \partial_\rho A_z)) - \partial_\phi \left(\frac{1}{\rho} \partial_\phi A_z - \partial_z A_\phi \right) \right) \\
&= \frac{1}{\rho} \partial_{z\rho} (\rho A_\rho) + \frac{1}{\rho} \partial_{z\phi} A_\phi + \partial_{zz} A_z - \frac{1}{\rho} \partial_\rho (\rho \partial_z A_\rho) + \frac{1}{\rho} \partial_\rho (\rho \partial_\rho A_z) + \frac{1}{\rho^2} \partial_{\phi \phi} A_z - \frac{1}{\rho} \partial_{\phi z} A_\phi \\
&= \frac{1}{\rho} \partial_\rho (\rho \partial_\rho A_z) + \frac{1}{\rho^2} \partial_{\phi \phi} A_z + \partial_{zz} A_z + \frac{1}{\rho} \partial_z A_\rho + \partial_{z\rho} A_\rho + \frac{1}{\rho} \partial_{z\phi} A_\phi - \frac{1}{\rho} \partial_z A_\rho - \partial_{\rho z} A_\rho - \frac{1}{\rho} \partial_{\phi z} A_\phi \\
&= \frac{1}{\rho} \partial_\rho (\rho \partial_\rho A_z) + \frac{1}{\rho^2} \partial_{\phi \phi} A_z + \partial_{zz} A_z
\end{aligned} \tag{F.9c}$$

Evaluating these was a fairly tedious and mechanical job, and would have been better suited to a computer algebra system than by hand as done here.

Explicit cylindrical Laplacian Let's try this a different way. The most obvious potential strategy is to just apply the Laplacian to the vector itself, but we need to include the unit vectors in such an operation

$$\nabla^2 \mathbf{A} = \nabla^2 (\hat{\rho} A_\rho + \hat{\phi} A_\phi + \hat{z} A_z). \quad (\text{F.10})$$

First we need to know the explicit form of the cylindrical Laplacian. From the painful expansion, we can guess that it is

$$\nabla^2 \psi = \frac{1}{\rho} \partial_\rho (\rho \partial_\rho \psi) + \frac{1}{\rho^2} \partial_{\phi\phi} \psi + \partial_{zz} \psi. \quad (\text{F.11})$$

Let's check that explicitly. Here I use the vector product where $\hat{\rho}^2 = \hat{\phi}^2 = \hat{z}^2 = 1$, and these vectors anticommute when different

$$\begin{aligned} \nabla^2 \psi &= \left(\hat{\rho} \partial_\rho + \frac{\hat{\phi}}{\rho} \partial_\phi + \hat{z} \partial_z \right) \left(\hat{\rho} \partial_\rho \psi + \frac{\hat{\phi}}{\rho} \partial_\phi \psi + \hat{z} \partial_z \psi \right) \\ &= \hat{\rho} \partial_\rho \left(\hat{\rho} \partial_\rho \psi + \frac{\hat{\phi}}{\rho} \partial_\phi \psi + \hat{z} \partial_z \psi \right) + \frac{\hat{\phi}}{\rho} \partial_\phi \left(\hat{\rho} \partial_\rho \psi + \frac{\hat{\phi}}{\rho} \partial_\phi \psi + \hat{z} \partial_z \psi \right) + \hat{z} \partial_z \left(\hat{\rho} \partial_\rho \psi + \frac{\hat{\phi}}{\rho} \partial_\phi \psi + \hat{z} \partial_z \psi \right) \\ &= \partial_{\rho\rho} \psi + \hat{\rho} \hat{\phi} \partial_\rho \left(\frac{1}{\rho} \partial_\phi \psi \right) + \hat{\rho} \hat{z} \partial_{\rho z} \psi + \frac{\hat{\phi}}{\rho} \partial_\phi (\hat{\rho} \partial_\rho \psi) \\ &\quad + \frac{\hat{\phi}}{\rho} \partial_\phi \left(\frac{\hat{\phi}}{\rho} \partial_\phi \psi \right) + \frac{\hat{\phi} \hat{z}}{\rho} \partial_{\phi z} \psi + \hat{z} \hat{\rho} \partial_{z\rho} \psi + \frac{\hat{z} \hat{\phi}}{\rho} \partial_{z\phi} \psi + \partial_{zz} \psi \\ &= \partial_{\rho\rho} \psi + \frac{1}{\rho} \partial_\rho \psi + \frac{1}{\rho^2} \partial_{\phi\phi} \psi + \partial_{zz} \psi + \hat{\rho} \hat{\phi} \left(-\frac{1}{\rho^2} \partial_\phi \psi + \frac{1}{\rho} \partial_{\rho\phi} \psi - \frac{1}{\rho} \partial_{\phi\rho} \psi + \frac{1}{\rho^2} \partial_\phi \psi \right) \\ &\quad + \hat{z} \hat{\rho} \left(-\partial_{\rho z} \psi + \partial_{z\rho} \psi \right) + \hat{\phi} \hat{z} \left(\frac{1}{\rho} \partial_{\phi z} \psi - \frac{1}{\rho} \partial_{z\phi} \psi \right) \\ &= \partial_{\rho\rho} \psi + \frac{1}{\rho} \partial_\rho \psi + \frac{1}{\rho^2} \partial_{\phi\phi} \psi + \partial_{zz} \psi, \end{aligned} \quad (\text{F.12})$$

so the Laplacian operator is

$$\nabla^2 = \frac{1}{\rho} \frac{\partial}{\partial \rho} \left(\rho \frac{\partial}{\partial \rho} \right) + \frac{1}{\rho^2} \frac{\partial^2}{\partial \phi^2} + \frac{\partial^2}{\partial z^2}. \quad (\text{F.13})$$

All the bivector grades of the Laplacian operator are seen to explicitly cancel, regardless of the grade of ψ , just as if we had expanded the scalar Laplacian as a dot product $\nabla^2 \psi = \nabla \cdot (\nabla \psi)$. Unlike such a scalar expansion, this derivation is seen to be valid for any grade ψ . We know now that we can trust this result when ψ is a scalar, a vector, a bivector, a trivector, or even a multivector.

Vector Laplacian Now that we trust that the typical scalar form of the Laplacian applies equally well to multivectors as it does to scalars, that cylindrical coordinate operator can now be applied to a vector. Consider the projections onto each of the directions in turn

$$\nabla^2(\hat{\rho}A_\rho) = \hat{\rho}\frac{1}{\rho}\partial_\rho(\rho\partial_\rho A_\rho) + \frac{1}{\rho^2}\partial_{\phi\phi}(\hat{\rho}A_\rho) + \hat{\rho}\partial_{zz}A_\rho \quad (\text{F.14})$$

$$\begin{aligned} \partial_{\phi\phi}(\hat{\rho}A_\rho) &= \partial_\phi(\hat{\phi}A_\rho + \hat{\rho}\partial_\phi A_\rho) \\ &= -\hat{\rho}A_\rho + \hat{\phi}\partial_\phi A_\rho + \hat{\phi}\partial_\phi A_\rho + \hat{\rho}\partial_{\phi\phi}A_\rho \\ &= \hat{\rho}(\partial_{\phi\phi}A_\rho - A_\rho) + 2\hat{\phi}\partial_\phi A_\rho \end{aligned} \quad (\text{F.15})$$

so this component of the vector Laplacian is

$$\begin{aligned} \nabla^2(\hat{\rho}A_\rho) &= \hat{\rho}\left(\frac{1}{\rho}\partial_\rho(\rho\partial_\rho A_\rho) + \frac{1}{\rho^2}\partial_{\phi\phi}A_\rho - \frac{1}{\rho^2}A_\rho + \partial_{zz}A_\rho\right) + \hat{\phi}\left(2\frac{1}{\rho^2}\partial_\phi A_\rho\right) \\ &= \hat{\rho}\left(\nabla^2 A_\rho - \frac{1}{\rho^2}A_\rho\right) + \hat{\phi}\frac{2}{\rho^2}\partial_\phi A_\rho. \end{aligned} \quad (\text{F.16})$$

The Laplacian for the projection of the vector onto the $\hat{\phi}$ direction is

$$\nabla^2(\hat{\phi}A_\phi) = \hat{\phi}\frac{1}{\rho}\partial_\rho(\rho\partial_\rho A_\phi) + \frac{1}{\rho^2}\partial_{\phi\phi}(\hat{\phi}A_\phi) + \hat{\phi}\partial_{zz}A_\phi, \quad (\text{F.17})$$

Again, since the unit vectors are ϕ dependent, the ϕ derivatives have to be treated carefully

$$\begin{aligned} \partial_{\phi\phi}(\hat{\phi}A_\phi) &= \partial_\phi(-\hat{\rho}A_\phi + \hat{\phi}\partial_\phi A_\phi) \\ &= -\hat{\phi}A_\phi - \hat{\rho}\partial_\phi A_\phi - \hat{\rho}\partial_\phi A_\phi + \hat{\phi}\partial_{\phi\phi}A_\phi \\ &= -2\hat{\rho}\partial_\phi A_\phi + \hat{\phi}(\partial_{\phi\phi}A_\phi - A_\phi), \end{aligned} \quad (\text{F.18})$$

so the Laplacian of this projection is

$$\begin{aligned} \nabla^2(\hat{\phi}A_\phi) &= \hat{\phi}\left(\frac{1}{\rho}\partial_\rho(\rho\partial_\rho A_\phi) + \hat{\phi}\partial_{zz}A_\phi, \frac{1}{\rho^2}\partial_{\phi\phi}A_\phi - \frac{A_\phi}{\rho^2}\right) - \hat{\rho}\frac{2}{\rho^2}\partial_\phi A_\phi \\ &= \hat{\phi}\left(\nabla^2 A_\phi - \frac{A_\phi}{\rho^2}\right) - \hat{\rho}\frac{2}{\rho^2}\partial_\phi A_\phi. \end{aligned} \quad (\text{F.19})$$

Since \hat{z} is fixed we have

$$\nabla^2\hat{z}A_z = \hat{z}\nabla^2 A_z. \quad (\text{F.20})$$

Putting all the pieces together we have

$$\nabla^2\mathbf{A} = \hat{\rho}\left(\nabla^2 A_\rho - \frac{1}{\rho^2}A_\rho - \frac{2}{\rho^2}\partial_\phi A_\rho\right) + \hat{\phi}\left(\nabla^2 A_\phi - \frac{A_\phi}{\rho^2} + \frac{2}{\rho^2}\partial_\phi A_\rho\right) + \hat{z}\nabla^2 A_z. \quad (\text{F.21})$$

This matches the result eq. (F.9) from the painful expansion of $\nabla(\nabla \cdot \mathbf{A}) - \nabla \times (\nabla \times \mathbf{A})$.

G

GRADIENT, DIVERGENCE, CURL AND LAPLACIAN IN SPHERICAL COORDINATES.

Unit vectors Two of the spherical unit vectors we can immediately write by inspection.

$$\begin{aligned}\hat{\mathbf{r}} &= \mathbf{e}_1 \sin \theta \cos \phi + \mathbf{e}_2 \sin \theta \sin \phi + \mathbf{e}_3 \cos \theta \\ \hat{\boldsymbol{\phi}} &= -\mathbf{e}_1 \sin \theta + \mathbf{e}_2 \cos \phi\end{aligned}\tag{G.1}$$

We can compute $\hat{\boldsymbol{\theta}}$ by utilizing the right hand triplet property

$$\begin{aligned}\hat{\boldsymbol{\theta}} &= \hat{\boldsymbol{\phi}} \times \hat{\mathbf{r}} \\ &= \begin{vmatrix} \mathbf{e}_1 & \mathbf{e}_2 & \mathbf{e}_3 \\ -S_\phi & C_\phi & 0 \\ S_\theta C_\phi & S_\theta S_\phi & C_\theta \end{vmatrix} \\ &= \mathbf{e}_1 (C_\theta C_\phi) + \mathbf{e}_2 (C_\theta S_\phi) + \mathbf{e}_3 (-S_\theta (S_\phi^2 + C_\phi^2)) \\ &= \mathbf{e}_1 \cos \theta \cos \phi + \mathbf{e}_2 \cos \theta \sin \phi - \mathbf{e}_3 \sin \theta.\end{aligned}\tag{G.2}$$

Here I've used $C_\theta = \cos \theta, S_\phi = \sin \phi, \dots$ as a convenient shorthand. Observe that with $i = \mathbf{e}_1 \mathbf{e}_2$, these unit vectors admit a small factorization that makes further manipulation easier

$$\begin{aligned}\hat{\mathbf{r}} &= \mathbf{e}_1 e^{i\phi} \sin \theta + \mathbf{e}_3 \cos \theta \\ \hat{\boldsymbol{\theta}} &= \cos \theta \mathbf{e}_1 e^{i\phi} - \sin \theta \mathbf{e}_3 \\ \hat{\boldsymbol{\phi}} &= \mathbf{e}_2 e^{i\phi}\end{aligned}\tag{G.3}$$

It should also be the case that $\hat{\mathbf{r}} \hat{\boldsymbol{\theta}} \hat{\boldsymbol{\phi}} = I$, where $I = \mathbf{e}_1 \mathbf{e}_2 \mathbf{e}_3 = \mathbf{e}_{123}$ is the \mathbb{R}^3 pseudoscalar, which is straightforward to check

$$\begin{aligned}\hat{\mathbf{r}} \hat{\boldsymbol{\theta}} \hat{\boldsymbol{\phi}} &= (\mathbf{e}_1 e^{i\phi} \sin \theta + \mathbf{e}_3 \cos \theta) (\cos \theta \mathbf{e}_1 e^{i\phi} - \sin \theta \mathbf{e}_3) \mathbf{e}_2 e^{i\phi} \\ &= (\sin \theta \cos \theta - \cos \theta \sin \theta + \mathbf{e}_{31} e^{i\phi} (\cos^2 \theta + \sin^2 \theta)) \mathbf{e}_2 e^{i\phi} \\ &= \mathbf{e}_{31} \mathbf{e}_2 e^{-i\phi} e^{i\phi} \\ &= \mathbf{e}_{123}.\end{aligned}\tag{G.4}$$

This property could also have been used to compute $\hat{\boldsymbol{\theta}}$.

Gradient To compute the gradient, note that the coordinate vectors for the spherical parameterization are

$$\begin{aligned}
 \mathbf{x}_r &= \frac{\partial \mathbf{r}}{\partial r} \\
 &= \frac{\partial(r\hat{\mathbf{r}})}{\partial r} \\
 &= \hat{\mathbf{r}} + r \frac{\partial \hat{\mathbf{r}}}{\partial r} \\
 &= \hat{\mathbf{r}},
 \end{aligned} \tag{G.5a}$$

$$\begin{aligned}
 \mathbf{x}_\theta &= \frac{\partial(r\hat{\mathbf{r}})}{\partial \theta} \\
 &= r \frac{\partial}{\partial \theta} (S_\theta \mathbf{e}_1 e^{i\phi} + C_\theta \mathbf{e}_3) \\
 &= r \frac{\partial}{\partial \theta} (C_\theta \mathbf{e}_1 e^{i\phi} - S_\theta \mathbf{e}_3) \\
 &= r \hat{\boldsymbol{\theta}},
 \end{aligned} \tag{G.5b}$$

$$\begin{aligned}
 \mathbf{x}_\phi &= \frac{\partial(r\hat{\mathbf{r}})}{\partial \phi} \\
 &= r \frac{\partial}{\partial \phi} (S_\theta \mathbf{e}_1 e^{i\phi} + C_\theta \mathbf{e}_3) \\
 &= r S_\theta \mathbf{e}_2 e^{i\phi} \\
 &= r \sin \theta \hat{\boldsymbol{\phi}}.
 \end{aligned} \tag{G.5c}$$

Since these are all normal, the dual vectors defined by $\mathbf{x}^j \cdot \mathbf{x}_k = \delta_k^j$, can be obtained by inspection

$$\begin{aligned}
 \mathbf{x}^r &= \hat{\mathbf{r}} \\
 \mathbf{x}^\theta &= \frac{1}{r} \hat{\boldsymbol{\theta}} \\
 \mathbf{x}^\phi &= \frac{1}{r \sin \theta} \hat{\boldsymbol{\phi}}.
 \end{aligned} \tag{G.6}$$

The gradient follows immediately

$$\nabla = \mathbf{x}^r \frac{\partial}{\partial r} + \mathbf{x}^\theta \frac{\partial}{\partial \theta} + \mathbf{x}^\phi \frac{\partial}{\partial \phi}, \tag{G.7}$$

or

$$\nabla = \hat{\mathbf{r}} \frac{\partial}{\partial r} + \frac{\hat{\boldsymbol{\theta}}}{r} \frac{\partial}{\partial \theta} + \frac{\hat{\boldsymbol{\phi}}}{r \sin \theta} \frac{\partial}{\partial \phi}. \quad (\text{G.8})$$

More information on this general dual-vector technique of computing the gradient in curvilinear coordinate systems can be found in [9].

Partials To compute the divergence, curl and Laplacian, we'll need the partials of each of the unit vectors $\partial \hat{\mathbf{r}} / \partial \theta$, $\partial \hat{\mathbf{r}} / \partial \phi$, $\partial \hat{\boldsymbol{\theta}} / \partial \theta$, $\partial \hat{\boldsymbol{\theta}} / \partial \phi$, $\partial \hat{\boldsymbol{\phi}} / \partial \phi$.

The $\hat{\boldsymbol{\theta}}$ partials are

$$\begin{aligned} \frac{\partial \hat{\boldsymbol{\theta}}}{\partial \theta} &= \frac{\partial}{\partial \theta} (C_\theta \mathbf{e}_1 e^{i\phi} - S_\theta \mathbf{e}_3) \\ &= -S_\theta \mathbf{e}_1 e^{i\phi} - C_\theta \mathbf{e}_3 \\ &= -\hat{\mathbf{r}}, \end{aligned} \quad (\text{G.9})$$

$$\begin{aligned} \frac{\partial \hat{\boldsymbol{\theta}}}{\partial \phi} &= \frac{\partial}{\partial \phi} (C_\theta \mathbf{e}_1 e^{i\phi} - S_\theta \mathbf{e}_3) \\ &= C_\theta \mathbf{e}_2 e^{i\phi} \\ &= C_\theta \hat{\boldsymbol{\phi}}. \end{aligned} \quad (\text{G.10})$$

The $\hat{\boldsymbol{\phi}}$ partials are

$$\begin{aligned} \frac{\partial \hat{\boldsymbol{\phi}}}{\partial \theta} &= \frac{\partial}{\partial \theta} \mathbf{e}_2 e^{i\phi} \\ &= 0. \end{aligned} \quad (\text{G.11})$$

$$\begin{aligned} \frac{\partial \hat{\boldsymbol{\phi}}}{\partial \phi} &= \frac{\partial}{\partial \phi} \mathbf{e}_2 e^{i\phi} \\ &= -\mathbf{e}_1 e^{i\phi} \\ &= -\hat{\mathbf{r}} \langle \hat{\mathbf{r}} \mathbf{e}_1 e^{i\phi} \rangle - \hat{\boldsymbol{\theta}} \langle \hat{\boldsymbol{\theta}} \mathbf{e}_1 e^{i\phi} \rangle - \hat{\boldsymbol{\phi}} \langle \hat{\boldsymbol{\phi}} \mathbf{e}_1 e^{i\phi} \rangle \\ &= -\hat{\mathbf{r}} \langle (\mathbf{e}_1 e^{i\phi} S_\theta + \mathbf{e}_3 C_\theta) \mathbf{e}_1 e^{i\phi} \rangle - \hat{\boldsymbol{\theta}} \langle (C_\theta \mathbf{e}_1 e^{i\phi} - S_\theta \mathbf{e}_3) \mathbf{e}_1 e^{i\phi} \rangle \\ &= -\hat{\mathbf{r}} \langle e^{-i\phi} S_\theta e^{i\phi} \rangle - \hat{\boldsymbol{\theta}} \langle C_\theta e^{-i\phi} e^{i\phi} \rangle \\ &= -\hat{\mathbf{r}} S_\theta - \hat{\boldsymbol{\theta}} C_\theta. \end{aligned} \quad (\text{G.12})$$

The $\hat{\mathbf{r}}$ partials are were computed as a side effect of evaluating \mathbf{x}_θ , and \mathbf{x}_ϕ , and are

$$\frac{\partial \hat{\mathbf{r}}}{\partial \theta} = \hat{\boldsymbol{\theta}}, \quad (\text{G.13})$$

$$\frac{\partial \hat{\mathbf{r}}}{\partial \phi} = S_\theta \hat{\boldsymbol{\phi}}. \quad (\text{G.14})$$

In summary

$\begin{aligned} \partial_\theta \hat{\mathbf{r}} &= \hat{\boldsymbol{\theta}} \\ \partial_\phi \hat{\mathbf{r}} &= S_\theta \hat{\boldsymbol{\phi}} \\ \partial_\theta \hat{\boldsymbol{\theta}} &= -\hat{\mathbf{r}} \\ \partial_\phi \hat{\boldsymbol{\theta}} &= C_\theta \hat{\boldsymbol{\phi}} \\ \partial_\theta \hat{\boldsymbol{\phi}} &= 0 \\ \partial_\phi \hat{\boldsymbol{\phi}} &= -\hat{\mathbf{r}} S_\theta - \hat{\boldsymbol{\theta}} C_\theta. \end{aligned}$	(G.15)
---	--------

Divergence and curl. The divergence and curl can be computed from the vector product of the spherical coordinate gradient and the spherical representation of a vector. That is

$$\nabla \mathbf{A} = \nabla \cdot \mathbf{A} + \nabla \wedge \mathbf{A} = \nabla \cdot \mathbf{A} + I \nabla \times \mathbf{A}. \quad (\text{G.16})$$

That gradient vector product is

$$\begin{aligned} \nabla \mathbf{A} &= \left(\hat{\mathbf{r}} \partial_r + \frac{\hat{\boldsymbol{\theta}}}{r} \partial_\theta + \frac{\hat{\boldsymbol{\phi}}}{r S_\theta} \partial_\phi \right) (\hat{\mathbf{r}} A_r + \hat{\boldsymbol{\theta}} A_\theta + \hat{\boldsymbol{\phi}} A_\phi) \\ &= \hat{\mathbf{r}} \partial_r (\hat{\mathbf{r}} A_r + \hat{\boldsymbol{\theta}} A_\theta + \hat{\boldsymbol{\phi}} A_\phi) \\ &\quad + \frac{\hat{\boldsymbol{\theta}}}{r} \partial_\theta (\hat{\mathbf{r}} A_r + \hat{\boldsymbol{\theta}} A_\theta + \hat{\boldsymbol{\phi}} A_\phi) \\ &\quad + \frac{\hat{\boldsymbol{\phi}}}{r S_\theta} \partial_\phi (\hat{\mathbf{r}} A_r + \hat{\boldsymbol{\theta}} A_\theta + \hat{\boldsymbol{\phi}} A_\phi) \\ &= (\partial_r A_r + \hat{\mathbf{r}} \hat{\boldsymbol{\theta}} \partial_r A_\theta + \hat{\mathbf{r}} \hat{\boldsymbol{\phi}} \partial_r A_\phi) \\ &\quad + \frac{1}{r} (\hat{\boldsymbol{\theta}} (\partial_\theta \hat{\mathbf{r}}) A_r + \hat{\boldsymbol{\theta}} (\partial_\theta \hat{\boldsymbol{\theta}}) A_\theta + \hat{\boldsymbol{\theta}} (\partial_\theta \hat{\boldsymbol{\phi}}) A_\phi + \hat{\boldsymbol{\theta}} \hat{\mathbf{r}} \partial_\theta A_r + \partial_\theta A_\theta + \hat{\boldsymbol{\theta}} \hat{\boldsymbol{\phi}} \partial_\theta A_\phi) \\ &\quad + \frac{1}{r S_\theta} (\hat{\boldsymbol{\phi}} (\partial_\phi \hat{\mathbf{r}}) A_r + \hat{\boldsymbol{\phi}} (\partial_\phi \hat{\boldsymbol{\theta}}) A_\theta + \hat{\boldsymbol{\phi}} (\partial_\phi \hat{\boldsymbol{\phi}}) A_\phi + \hat{\boldsymbol{\phi}} \hat{\mathbf{r}} \partial_\phi A_r + \hat{\boldsymbol{\phi}} \hat{\boldsymbol{\theta}} \partial_\phi A_\theta + \partial_\phi A_\phi) \\ &= (\partial_r A_r + \hat{\mathbf{r}} \hat{\boldsymbol{\theta}} \partial_r A_\theta + \hat{\mathbf{r}} \hat{\boldsymbol{\phi}} \partial_r A_\phi) \\ &\quad + \frac{1}{r} (\hat{\boldsymbol{\theta}} (\hat{\boldsymbol{\theta}}) A_r + \hat{\boldsymbol{\theta}} (-\hat{\mathbf{r}}) A_\theta + \hat{\boldsymbol{\theta}} (0) A_\phi + \hat{\boldsymbol{\theta}} \hat{\mathbf{r}} \partial_\theta A_r + \partial_\theta A_\theta + \hat{\boldsymbol{\theta}} \hat{\boldsymbol{\phi}} \partial_\theta A_\phi) \\ &\quad + \frac{1}{r S_\theta} (\hat{\boldsymbol{\phi}} (S_\theta \hat{\boldsymbol{\phi}}) A_r + \hat{\boldsymbol{\phi}} (C_\theta \hat{\boldsymbol{\phi}}) A_\theta - \hat{\boldsymbol{\phi}} (\hat{\mathbf{r}} S_\theta + \hat{\boldsymbol{\theta}} C_\theta) A_\phi + \hat{\boldsymbol{\phi}} \hat{\mathbf{r}} \partial_\phi A_r + \hat{\boldsymbol{\phi}} \hat{\boldsymbol{\theta}} \partial_\phi A_\theta + \partial_\phi A_\phi). \end{aligned} \quad (\text{G.17})$$

The scalar component of this is the divergence

$$\begin{aligned}
\nabla \cdot \mathbf{A} &= \partial_r A_r + \frac{A_r}{r} + \frac{1}{r} \partial_\theta A_\theta + \frac{1}{r S_\theta} (S_\theta A_r + C_\theta A_\theta + \partial_\phi A_\phi) \\
&= \partial_r A_r + 2 \frac{A_r}{r} + \frac{1}{r} \partial_\theta A_\theta + \frac{1}{r S_\theta} C_\theta A_\theta + \frac{1}{r S_\theta} \partial_\phi A_\phi \\
&= \partial_r A_r + 2 \frac{A_r}{r} + \frac{1}{r} \partial_\theta A_\theta + \frac{1}{r S_\theta} C_\theta A_\theta + \frac{1}{r S_\theta} \partial_\phi A_\phi,
\end{aligned} \tag{G.18}$$

which can be factored as

$$\nabla \cdot \mathbf{A} = \frac{1}{r^2} \partial_r (r^2 A_r) + \frac{1}{r S_\theta} \partial_\theta (S_\theta A_\theta) + \frac{1}{r S_\theta} \partial_\phi A_\phi. \tag{G.19}$$

The bivector grade of $\nabla \mathbf{A}$ is the bivector curl

$$\begin{aligned}
\nabla \wedge \mathbf{A} &= (\hat{\mathbf{r}} \hat{\theta} \partial_r A_\theta + \hat{\mathbf{r}} \hat{\phi} \partial_r A_\phi) + \frac{1}{r} (\hat{\theta} (-\hat{\mathbf{r}}) A_\theta + \hat{\theta} \hat{\mathbf{r}} \partial_\theta A_r + \hat{\theta} \hat{\phi} \partial_\theta A_\phi) \\
&\quad + \frac{1}{r S_\theta} (-\hat{\phi} (\hat{\mathbf{r}} S_\theta + \hat{\theta} C_\theta) A_\phi + \hat{\phi} \hat{\mathbf{r}} \partial_\phi A_r + \hat{\phi} \hat{\theta} \partial_\phi A_\theta) \\
&= (\hat{\mathbf{r}} \hat{\theta} \partial_r A_\theta - \hat{\phi} \hat{\mathbf{r}} \partial_r A_\phi) + \frac{1}{r} (\hat{\mathbf{r}} \hat{\theta} A_\theta - \hat{\mathbf{r}} \hat{\theta} \partial_\theta A_r + \hat{\theta} \hat{\phi} \partial_\theta A_\phi) \\
&\quad + \frac{1}{r S_\theta} (-\hat{\phi} \hat{\mathbf{r}} S_\theta A_\phi + \hat{\theta} \hat{\phi} C_\theta A_\phi + \hat{\phi} \hat{\mathbf{r}} \partial_\phi A_r - \hat{\theta} \hat{\phi} \partial_\phi A_\theta) \\
&= \hat{\theta} \hat{\phi} \left(\frac{1}{r S_\theta} C_\theta A_\phi + \frac{1}{r} \partial_\theta A_\phi - \frac{1}{r S_\theta} \partial_\phi A_\theta \right) \\
&\quad + \hat{\phi} \hat{\mathbf{r}} \left(-\partial_r A_\phi + \frac{1}{r S_\theta} (-S_\theta A_\phi + \partial_\phi A_r) \right) + \hat{\mathbf{r}} \hat{\theta} \left(\partial_r A_\theta + \frac{1}{r} A_\theta - \frac{1}{r} \partial_\theta A_r \right) \\
&= I \hat{\mathbf{r}} \left(\frac{1}{r S_\theta} \partial_\theta (S_\theta A_\phi) - \frac{1}{r S_\theta} \partial_\phi A_\theta \right) + I \hat{\theta} \left(\frac{1}{r S_\theta} \partial_\phi A_r - \frac{1}{r} \partial_r (r A_\phi) \right) + I \hat{\phi} \left(\frac{1}{r} \partial_r (r A_\theta) - \frac{1}{r} \partial_\theta A_r \right)
\end{aligned} \tag{G.20}$$

This gives

$$\nabla \times \mathbf{A} = \hat{\mathbf{r}} \left(\frac{1}{r S_\theta} \partial_\theta (S_\theta A_\phi) - \frac{1}{r S_\theta} \partial_\phi A_\theta \right) + \hat{\theta} \left(\frac{1}{r S_\theta} \partial_\phi A_r - \frac{1}{r} \partial_r (r A_\phi) \right) + \hat{\phi} \left(\frac{1}{r} \partial_r (r A_\theta) - \frac{1}{r} \partial_\theta A_r \right). \tag{G.21}$$

This and the divergence result above both check against the back cover of [8].

Laplacian Using the divergence and curl it's possible to compute the Laplacian from those, but we saw in cylindrical coordinates that it was much harder to do it that way than to do it directly.

$$\begin{aligned}
\nabla^2\psi &= \left(\hat{\mathbf{r}}\partial_r + \frac{\hat{\theta}}{r}\partial_\theta + \frac{\hat{\phi}}{rS_\theta}\partial_\phi\right)\left(\hat{\mathbf{r}}\partial_r\psi + \frac{\hat{\theta}}{r}\partial_\theta\psi + \frac{\hat{\phi}}{rS_\theta}\partial_\phi\psi\right) \\
&= \partial_{rr}\psi + \hat{\mathbf{r}}\hat{\theta}\partial_r\left(\frac{1}{r}\partial_\theta\psi\right) + \hat{\mathbf{r}}\hat{\phi}\frac{1}{S_\theta}\partial_r\left(\frac{1}{r}\partial_\phi\psi\right) \\
&\quad + \frac{\hat{\theta}}{r}\partial_\theta(\hat{\mathbf{r}}\partial_r\psi) + \frac{\hat{\theta}}{r^2}\partial_\theta(\hat{\theta}\partial_\theta\psi) + \frac{\hat{\theta}}{r^2}\partial_\theta\left(\frac{\hat{\phi}}{S_\theta}\partial_\phi\psi\right) \\
&\quad + \frac{\hat{\phi}}{rS_\theta}\partial_\phi(\hat{\mathbf{r}}\partial_r\psi) + \frac{\hat{\phi}}{r^2S_\theta}\partial_\phi(\hat{\theta}\partial_\theta\psi) + \frac{\hat{\phi}}{r^2S_\theta^2}\partial_\phi(\hat{\phi}\partial_\phi\psi) \\
&= \partial_{rr}\psi + \hat{\mathbf{r}}\hat{\theta}\partial_r\left(\frac{1}{r}\partial_\theta\psi\right) + \hat{\mathbf{r}}\hat{\phi}\frac{1}{S_\theta}\partial_r\left(\frac{1}{r}\partial_\phi\psi\right) \\
&\quad + \frac{\hat{\theta}\hat{\mathbf{r}}}{r}\partial_\theta(\partial_r\psi) + \frac{1}{r^2}\partial_{\theta\theta}\psi + \frac{\hat{\theta}\hat{\phi}}{r^2}\partial_\theta\left(\frac{1}{S_\theta}\partial_\phi\psi\right) \\
&\quad + \frac{\hat{\phi}\hat{\mathbf{r}}}{rS_\theta}\partial_{\phi r}\psi + \frac{\hat{\phi}\hat{\theta}}{r^2S_\theta}\partial_{\phi\theta}\psi + \frac{1}{r^2S_\theta^2}\partial_{\phi\phi}\psi \\
&\quad + \frac{\hat{\theta}}{r}(\partial_\theta\hat{\mathbf{r}})\partial_r\psi + \frac{\hat{\theta}}{r^2}(\partial_\theta\hat{\theta})\partial_\theta\psi + \frac{\hat{\theta}}{r^2}(\partial_\theta\hat{\phi})\frac{\hat{\phi}}{S_\theta}\partial_\phi\psi \\
&\quad + \frac{\hat{\phi}}{rS_\theta}(\partial_\phi\hat{\mathbf{r}})\partial_r\psi + \frac{\hat{\phi}}{r^2S_\theta}(\partial_\phi\hat{\theta})\partial_\theta\psi + \frac{\hat{\phi}}{r^2S_\theta^2}(\partial_\phi\hat{\phi})\partial_\phi\psi \\
&= \partial_{rr}\psi + \hat{\mathbf{r}}\hat{\theta}\partial_r\left(\frac{1}{r}\partial_\theta\psi\right) + \hat{\mathbf{r}}\hat{\phi}\frac{1}{S_\theta}\partial_r\left(\frac{1}{r}\partial_\phi\psi\right) \\
&\quad + \frac{\hat{\theta}\hat{\mathbf{r}}}{r}\partial_\theta(\partial_r\psi) + \frac{1}{r^2}\partial_{\theta\theta}\psi + \frac{\hat{\theta}\hat{\phi}}{r^2}\partial_\theta\left(\frac{1}{S_\theta}\partial_\phi\psi\right) \\
&\quad + \frac{\hat{\phi}\hat{\mathbf{r}}}{rS_\theta}\partial_{\phi r}\psi + \frac{\hat{\phi}\hat{\theta}}{r^2S_\theta}\partial_{\phi\theta}\psi + \frac{1}{r^2S_\theta^2}\partial_{\phi\phi}\psi \\
&\quad + \frac{\hat{\theta}}{r}(\hat{\theta})\partial_r\psi + \frac{\hat{\theta}}{r^2}(-\hat{\mathbf{r}})\partial_\theta\psi + \frac{\hat{\theta}}{r^2}(0)\frac{\hat{\phi}}{S_\theta}\partial_\phi\psi \\
&\quad + \frac{\hat{\phi}}{rS_\theta}(S_\theta\hat{\phi})\partial_r\psi + \frac{\hat{\phi}}{r^2S_\theta}(C_\theta\hat{\phi})\partial_\theta\psi + \frac{\hat{\phi}}{r^2S_\theta^2}(-\hat{\mathbf{r}}S_\theta - \hat{\theta}C_\theta)\partial_\phi\psi
\end{aligned} \tag{G.22}$$

All the bivector factors are expected to cancel out, but this should be checked. Those with an $\hat{\mathbf{r}}\hat{\theta}$ factor are

$$\begin{aligned} \partial_r \left(\frac{1}{r} \partial_\theta \psi \right) - \frac{1}{r} \partial_{\theta r} \psi + \frac{1}{r^2} \partial_\theta \psi &= -\frac{1}{r^2} \partial_\theta \psi + \frac{1}{r} \partial_{r\theta} \psi - \frac{1}{r} \partial_{\theta r} \psi + \frac{1}{r^2} \partial_\theta \psi \\ &= 0, \end{aligned} \quad (\text{G.23})$$

and those with a $\hat{\theta}\hat{\phi}$ factor are

$$\begin{aligned} \frac{1}{r^2} \partial_\theta \left(\frac{1}{S_\theta} \partial_\phi \psi \right) - \frac{1}{r^2 S_\theta} \partial_{\phi\theta} \psi + \frac{1}{r^2 S_\theta^2} C_\theta \partial_\phi \psi &= -\frac{1}{r^2} \frac{C_\theta}{S_\theta^2} \partial_\phi \psi + \frac{1}{r^2 S_\theta} \partial_{\theta\phi} \psi - \frac{1}{r^2 S_\theta} \partial_{\phi\theta} \psi + \frac{1}{r^2 S_\theta^2} C_\theta \partial_\phi \psi \\ &= 0, \end{aligned} \quad (\text{G.24})$$

and those with a $\hat{\phi}\hat{r}$ factor are

$$\begin{aligned} -\frac{1}{S_\theta} \partial_r \left(\frac{1}{r} \partial_\phi \psi \right) + \frac{1}{r S_\theta} \partial_{\phi r} \psi - \frac{1}{r^2 S_\theta^2} S_\theta \partial_\phi \psi &= \frac{1}{S_\theta} \frac{1}{r^2} \partial_\phi \psi - \frac{1}{r S_\theta} \partial_{r\phi} \psi + \frac{1}{r S_\theta} \partial_{\phi r} \psi - \frac{1}{r^2 S_\theta^2} S_\theta \partial_\phi \psi \\ &= 0. \end{aligned}$$

This leaves

$$\nabla^2 \psi = \partial_{rr} \psi + \frac{2}{r} \partial_r \psi + \frac{1}{r^2} \partial_{\theta\theta} \psi + \frac{1}{r^2 S_\theta} C_\theta \partial_\theta \psi + \frac{1}{r^2 S_\theta^2} \partial_{\phi\phi} \psi. \quad (\text{G.26})$$

This factors nicely as

$$\boxed{\nabla^2 \psi = \frac{1}{r^2} \frac{\partial}{\partial r} \left(r^2 \frac{\partial \psi}{\partial r} \right) + \frac{1}{r^2 \sin \theta} \frac{\partial}{\partial \theta} \left(\sin \theta \frac{\partial \psi}{\partial \theta} \right) + \frac{1}{r^2 \sin^2 \theta} \frac{\partial^2 \psi}{\partial \phi^2}}, \quad (\text{G.27})$$

which checks against the back cover of Jackson. Here it has been demonstrated explicitly that this operator expression is valid for multivector fields ψ as well as scalar fields ψ .



VECTOR WAVE EQUATION IN SPHERICAL COORDINATES

For a vector \mathbf{A} in spherical coordinates, let's compute the Laplacian

$$\nabla^2 \mathbf{A}, \quad (\text{H.1})$$

to see the form of the wave equation. The spherical vector representation has a curvilinear basis

$$\mathbf{A} = \hat{\mathbf{r}}A_r + \hat{\boldsymbol{\theta}}A_\theta + \hat{\boldsymbol{\phi}}A_\phi, \quad (\text{H.2})$$

and the spherical Laplacian has been found to have the representation

$$\nabla^2 \psi = \frac{1}{r^2} \frac{\partial}{\partial r} \left(r^2 \frac{\partial \psi}{\partial r} \right) + \frac{1}{r^2 \sin \theta} \frac{\partial}{\partial \theta} \left(\sin \theta \frac{\partial \psi}{\partial \theta} \right) + \frac{1}{r^2 \sin^2 \theta} \frac{\partial^2 \psi}{\partial \phi^2}. \quad (\text{H.3})$$

Evaluating the Laplacian will require the following curvilinear basis derivatives

$$\begin{aligned} \partial_\theta \hat{\mathbf{r}} &= \hat{\boldsymbol{\theta}} \\ \partial_\theta \hat{\boldsymbol{\theta}} &= -\hat{\mathbf{r}} \\ \partial_\theta \hat{\boldsymbol{\phi}} &= 0 \\ \partial_\phi \hat{\mathbf{r}} &= S_\theta \hat{\boldsymbol{\phi}} \\ \partial_\phi \hat{\boldsymbol{\theta}} &= C_\theta \hat{\boldsymbol{\phi}} \\ \partial_\phi \hat{\boldsymbol{\phi}} &= -\hat{\mathbf{r}}S_\theta - \hat{\boldsymbol{\theta}}C_\theta. \end{aligned} \quad (\text{H.4})$$

We'll need to evaluate a number of derivatives. Starting with the $\hat{\mathbf{r}}$ components

$$\partial_r (r^2 \partial_r (\hat{\mathbf{r}}\psi)) = \hat{\mathbf{r}} \partial_r (r^2 \partial_r \psi) \quad (\text{H.5a})$$

$$\begin{aligned} \partial_\theta (S_\theta \partial_\theta (\hat{\mathbf{r}}\psi)) &= \partial_\theta (S_\theta (\hat{\boldsymbol{\theta}}\psi + \hat{\mathbf{r}}\partial_\theta \psi)) \\ &= C_\theta (\hat{\boldsymbol{\theta}}\psi + \hat{\mathbf{r}}\partial_\theta \psi) + S_\theta \partial_\theta (\hat{\boldsymbol{\theta}}\psi + \hat{\mathbf{r}}\partial_\theta \psi) \\ &= C_\theta (\hat{\boldsymbol{\theta}}\psi + \hat{\mathbf{r}}\partial_\theta \psi) + S_\theta \partial_\theta ((\partial_\theta \hat{\boldsymbol{\theta}})\psi + (\partial_\theta \hat{\mathbf{r}})\partial_\theta \psi) + S_\theta \partial_\theta (\hat{\boldsymbol{\theta}}\partial_\theta \psi + \hat{\mathbf{r}}\partial_{\theta\theta} \psi) \\ &= C_\theta (\hat{\boldsymbol{\theta}}\psi + \hat{\mathbf{r}}\partial_\theta \psi) + S_\theta ((-\hat{\mathbf{r}})\psi + (\hat{\boldsymbol{\theta}})\partial_\theta \psi) + S_\theta (\hat{\boldsymbol{\theta}}\partial_\theta \psi + \hat{\mathbf{r}}\partial_{\theta\theta} \psi) \\ &= \hat{\mathbf{r}} (C_\theta \partial_\theta \psi - S_\theta \psi + S_\theta \partial_{\theta\theta} \psi) + \hat{\boldsymbol{\theta}} (C_\theta \psi + 2S_\theta \partial_\theta \psi) \end{aligned} \quad (\text{H.5b})$$

$$\begin{aligned}
\partial_{\phi\phi}(\hat{\mathbf{r}}\psi) &= \partial_{\phi}((\partial_{\phi}\hat{\mathbf{r}})\psi + \hat{\mathbf{r}}\partial_{\phi}\psi) \\
&= \partial_{\phi}(S_{\theta}\hat{\boldsymbol{\phi}})\psi + \hat{\mathbf{r}}\partial_{\phi}\psi \\
&= S_{\theta}\partial_{\phi}(\hat{\boldsymbol{\phi}}\psi) + \partial_{\phi}(\hat{\mathbf{r}}\partial_{\phi}\psi) \\
&= S_{\theta}(\partial_{\phi}\hat{\boldsymbol{\phi}})\psi + S_{\theta}\hat{\boldsymbol{\phi}}\partial_{\phi}\psi + (\partial_{\phi}\hat{\mathbf{r}})\partial_{\phi}\psi + \hat{\mathbf{r}}\partial_{\phi\phi}\psi \\
&= S_{\theta}(-S_{\theta}\hat{\mathbf{r}} - C_{\theta}\hat{\boldsymbol{\theta}})\psi + S_{\theta}\hat{\boldsymbol{\phi}}\partial_{\phi}\psi + (S_{\theta}\hat{\boldsymbol{\phi}})\partial_{\phi}\psi + \hat{\mathbf{r}}\partial_{\phi\phi}\psi \\
&= \hat{\mathbf{r}}(-S_{\theta}^2\psi + \partial_{\phi\phi}\psi) + \hat{\boldsymbol{\theta}}(-S_{\theta}C_{\theta}\psi) + \hat{\boldsymbol{\phi}}(2S_{\theta}\hat{\boldsymbol{\phi}}\partial_{\phi}\psi)
\end{aligned} \tag{H.5c}$$

This gives

$$\begin{aligned}
\nabla^2(\hat{\mathbf{r}}A_r) &= \hat{\mathbf{r}}\left(\frac{1}{r^2}\partial_r(r^2\partial_r A_r) + \frac{1}{r^2S_{\theta}}(C_{\theta}\partial_{\theta}A_r - S_{\theta}A_r + S_{\theta}\partial_{\theta\theta}A_r) + \frac{1}{r^2S_{\theta}^2}(-S_{\theta}^2A_r + \partial_{\phi\phi}A_r)\right) \\
&\quad + \hat{\boldsymbol{\theta}}\left(\frac{1}{r^2S_{\theta}}(C_{\theta}A_r + 2S_{\theta}\partial_{\theta}A_r) - \frac{1}{r^2S_{\theta}}S_{\theta}C_{\theta}A_r\right) + \hat{\boldsymbol{\phi}}\left(\frac{1}{r^2S_{\theta}^2}2S_{\theta}\partial_{\phi}A_r\right) \\
&= \hat{\mathbf{r}}\left(\nabla^2 A_r - \frac{2}{r^2}A_r\right) + \frac{\hat{\boldsymbol{\theta}}}{r^2}\left(\frac{C_{\theta}}{S_{\theta}}A_r + 2\partial_{\theta}A_r - C_{\theta}A_r\right) + \hat{\boldsymbol{\phi}}\frac{2}{r^2S_{\theta}}\partial_{\phi}A_r.
\end{aligned} \tag{H.6}$$

Next, let's compute the derivatives of the $\hat{\boldsymbol{\theta}}$ projection.

$$\partial_r(r^2\partial_r(\hat{\boldsymbol{\theta}}\psi)) = \hat{\boldsymbol{\theta}}\partial_r(r^2\partial_r\psi) \tag{H.7a}$$

$$\begin{aligned}
\partial_{\theta}(S_{\theta}\partial_{\theta}(\hat{\boldsymbol{\theta}}\psi)) &= \partial_{\theta}(S_{\theta}((\partial_{\theta}\hat{\boldsymbol{\theta}})\psi + \hat{\boldsymbol{\theta}}\partial_{\theta}\psi)) \\
&= \partial_{\theta}(S_{\theta}((-\hat{\mathbf{r}})\psi + \hat{\boldsymbol{\theta}}\partial_{\theta}\psi)) \\
&= C_{\theta}(-\hat{\mathbf{r}}\psi + \hat{\boldsymbol{\theta}}\partial_{\theta}\psi) + S_{\theta}(-(\partial_{\theta}\hat{\mathbf{r}})\psi - \hat{\mathbf{r}}\partial_{\theta}\psi + (\partial_{\theta}\hat{\boldsymbol{\theta}})\partial_{\theta}\psi + \hat{\boldsymbol{\theta}}\partial_{\theta\theta}\psi) \\
&= C_{\theta}(-\hat{\mathbf{r}}\psi + \hat{\boldsymbol{\theta}}\partial_{\theta}\psi) + S_{\theta}(-(\hat{\boldsymbol{\theta}})\psi - \hat{\mathbf{r}}\partial_{\theta}\psi + (-\hat{\mathbf{r}})\partial_{\theta}\psi + \hat{\boldsymbol{\theta}}\partial_{\theta\theta}\psi) \\
&= \hat{\mathbf{r}}(-C_{\theta}\psi - 2S_{\theta}\partial_{\theta}\psi) + \hat{\boldsymbol{\theta}}(+C_{\theta}\partial_{\theta}\psi - S_{\theta}\psi + S_{\theta}\partial_{\theta\theta}\psi) \\
&= \hat{\mathbf{r}}(-C_{\theta}\psi - 2S_{\theta}\partial_{\theta}\psi) + \hat{\boldsymbol{\theta}}(+\partial_{\theta}(S_{\theta}\partial_{\theta}\psi) - S_{\theta}\psi)
\end{aligned} \tag{H.7b}$$

$$\begin{aligned}
\partial_{\phi\phi}(\hat{\boldsymbol{\theta}}\psi) &= \partial_{\phi}((\partial_{\phi}\hat{\boldsymbol{\theta}})\psi + \hat{\boldsymbol{\theta}}\partial_{\phi}\psi) \\
&= \partial_{\phi}(C_{\theta}\hat{\boldsymbol{\phi}})\psi + \hat{\boldsymbol{\theta}}\partial_{\phi}\psi \\
&= C_{\theta}\partial_{\phi}(\hat{\boldsymbol{\phi}}\psi) + \partial_{\phi}(\hat{\boldsymbol{\theta}}\partial_{\phi}\psi) \\
&= C_{\theta}(\partial_{\phi}\hat{\boldsymbol{\phi}})\psi + C_{\theta}\hat{\boldsymbol{\phi}}\partial_{\phi}\psi + (\partial_{\phi}\hat{\boldsymbol{\theta}})\partial_{\phi}\psi + \hat{\boldsymbol{\theta}}\partial_{\phi\phi}\psi \\
&= C_{\theta}(-\hat{\mathbf{r}}S_{\theta} - \hat{\boldsymbol{\theta}}C_{\theta})\psi + C_{\theta}\hat{\boldsymbol{\phi}}\partial_{\phi}\psi + (C_{\theta}\hat{\boldsymbol{\phi}})\partial_{\phi}\psi + \hat{\boldsymbol{\theta}}\partial_{\phi\phi}\psi \\
&= -\hat{\mathbf{r}}C_{\theta}S_{\theta}\psi + \hat{\boldsymbol{\theta}}(-C_{\theta}C_{\theta}\psi + \partial_{\phi\phi}\psi) + 2\hat{\boldsymbol{\phi}}C_{\theta}\partial_{\phi}\psi,
\end{aligned} \tag{H.7c}$$

which gives

$$\begin{aligned}
 \nabla^2(\hat{\theta}A_\theta) &= \hat{\mathbf{r}} \left(\frac{1}{r^2 S_\theta} (-C_\theta A_\theta - 2S_\theta \partial_\theta A_\theta) - \frac{1}{r^2 S_\theta^2} C_\theta S_\theta A_\theta \right) \\
 &\quad + \hat{\theta} \left(\frac{1}{r^2} \partial_r (r^2 \partial_r A_\theta) + \frac{1}{r^2 S_\theta} (+\partial_\theta (S_\theta \partial_\theta A_\theta) - S_\theta A_\theta) + \frac{1}{r^2 S_\theta^2} (-C_\theta C_\theta A_\theta + \partial_{\phi\phi} A_\theta) \right) \\
 &\quad + \hat{\phi} \left(\frac{1}{r^2 S_\theta^2} 2C_\theta \partial_\phi A_\theta \right) \\
 &= -2\hat{\mathbf{r}} \frac{1}{r^2 S_\theta} \partial_\theta (S_\theta A_\theta) + \hat{\theta} \left(\nabla^2 A_\theta - \frac{1}{r^2} A_\theta - \frac{1}{r^2 S_\theta^2} C_\theta^2 A_\theta \right) + 2\hat{\phi} \left(\frac{1}{r^2 S_\theta^2} C_\theta \partial_\phi A_\theta \right).
 \end{aligned} \tag{H.8}$$

Finally, we can compute the derivatives of the $\hat{\phi}$ projection.

$$\partial_r (r^2 \partial_r (\hat{\phi}\psi)) = \hat{\phi} \partial_r (r^2 \partial_r \psi) \tag{H.9a}$$

$$\partial_\theta (S_\theta \partial_\theta (\hat{\phi}\psi)) = \hat{\phi} \partial_\theta (S_\theta \partial_\theta \psi) \tag{H.9b}$$

$$\begin{aligned}
 \partial_{\phi\phi} (\hat{\phi}\psi) &= \partial_\phi ((\partial_\phi \hat{\phi})\psi + \hat{\phi} \partial_\phi \psi) \\
 &= \partial_\phi ((-\hat{\mathbf{r}} S_\theta - \hat{\theta} C_\theta)\psi + \hat{\phi} \partial_\phi \psi) \\
 &= -((\partial_\phi \hat{\mathbf{r}}) S_\theta + (\partial_\phi \hat{\theta}) C_\theta)\psi - (\hat{\mathbf{r}} S_\theta + \hat{\theta} C_\theta) \partial_\phi \psi + (\partial_\phi \hat{\phi} \partial_\phi \psi + \hat{\phi} \partial_{\phi\phi} \psi) \\
 &= -(S_\theta \partial_\phi \hat{\phi})\psi + (C_\theta \partial_\phi \hat{\phi}) C_\theta \psi - (\hat{\mathbf{r}} S_\theta + \hat{\theta} C_\theta) \partial_\phi \psi + (-\hat{\mathbf{r}} S_\theta - \hat{\theta} C_\theta) \partial_\phi \psi + \hat{\phi} \partial_{\phi\phi} \psi \\
 &= -2\hat{\mathbf{r}} S_\theta \partial_\phi \psi - 2\hat{\theta} C_\theta \partial_\phi \psi + \hat{\phi} (\partial_{\phi\phi} \psi - \psi),
 \end{aligned} \tag{H.9c}$$

which gives

$$\begin{aligned}
 \nabla^2(\hat{\phi}A_\phi) &= -2\hat{\mathbf{r}} \frac{1}{r^2 S_\theta} \partial_\phi A_\phi - 2\hat{\theta} \frac{1}{r^2 S_\theta^2} C_\theta \partial_\phi A_\phi \\
 &\quad + \hat{\phi} \left(\frac{1}{r^2} \partial_r (r^2 \partial_r A_\phi) + \frac{1}{r^2 S_\theta} \partial_\theta (S_\theta \partial_\theta A_\phi) + \frac{1}{r^2 S_\theta^2} (\partial_{\phi\phi} A_\phi - A_\phi) \right) \\
 &= -2\hat{\mathbf{r}} \frac{1}{r^2 S_\theta} \partial_\phi A_\phi - 2\hat{\theta} \frac{1}{r^2 S_\theta^2} C_\theta \partial_\phi A_\phi + \hat{\phi} \left(\nabla^2 A_\phi - \frac{1}{r^2} A_\phi \right).
 \end{aligned} \tag{H.10}$$

The vector Laplacian resolves into three augmented scalar wave equations, all highly coupled

$$\begin{aligned}
\hat{\mathbf{r}} \cdot (\nabla^2 \mathbf{A}) &= \nabla^2 A_r - \frac{2}{r^2} A_r - \frac{2}{r^2 S_\theta} \partial_\theta (S_\theta A_\theta) - \frac{2}{r^2 S_\theta} \partial_\phi A_\phi \\
\hat{\boldsymbol{\theta}} \cdot (\nabla^2 \mathbf{A}) &= \frac{1}{r^2} \frac{C_\theta}{S_\theta} A_r + \frac{2}{r^2} \partial_\theta A_r - \frac{1}{r^2} C_\theta A_r + \nabla^2 A_\theta - \frac{1}{r^2} A_\theta - \frac{1}{r^2 S_\theta^2} C_\theta^2 A_\theta - 2 \frac{1}{r^2 S_\theta^2} C_\theta \partial_\phi A_\phi \\
\hat{\boldsymbol{\phi}} \cdot (\nabla^2 \mathbf{A}) &= \frac{2}{r^2 S_\theta} \partial_\phi A_r + \frac{2}{r^2 S_\theta^2} C_\theta \partial_\phi A_\theta + \nabla^2 A_\phi - \frac{1}{r^2} A_\phi.
\end{aligned}$$

(H.11)

I'd guess one way to decouple these equations would be to impose a constraint that allows all the non-wave equation terms in one of the component equations to be killed, and then substitute that constraint into the remaining equations. Let's try one such constraint

$$A_r = -\frac{1}{S_\theta} \partial_\theta (S_\theta A_\theta) - \frac{1}{S_\theta} \partial_\phi A_\phi. \quad (\text{H.12})$$

This gives

$$\begin{aligned}
\hat{\mathbf{r}} \cdot (\nabla^2 \mathbf{A}) &= \nabla^2 A_r \\
\hat{\boldsymbol{\theta}} \cdot (\nabla^2 \mathbf{A}) &= \left(\frac{1}{r^2} \frac{C_\theta}{S_\theta} + \frac{2}{r^2} \partial_\theta - \frac{1}{r^2} C_\theta \right) \left(-\frac{1}{S_\theta} \partial_\theta (S_\theta A_\theta) - \frac{1}{S_\theta} \partial_\phi A_\phi \right) \\
&\quad + \nabla^2 A_\theta - \frac{1}{r^2} A_\theta - \frac{1}{r^2 S_\theta^2} C_\theta^2 A_\theta - \frac{2}{r^2 S_\theta^2} C_\theta \partial_\phi A_\phi \\
\hat{\boldsymbol{\phi}} \cdot (\nabla^2 \mathbf{A}) &= -\frac{2}{r^2 S_\theta} \partial_\phi \left(\frac{1}{S_\theta} \partial_\theta (S_\theta A_\theta) + \frac{1}{S_\theta} \partial_\phi A_\phi \right) + \frac{2}{r^2 S_\theta^2} C_\theta \partial_\phi A_\theta + \nabla^2 A_\phi - \frac{1}{r^2} A_\phi \\
&= -\frac{2}{r^2 S_\theta} \partial_\theta A_\theta - \frac{2}{r^2 S_\theta^2} \partial_{\phi\phi} A_\theta + \nabla^2 A_\phi - \frac{1}{r^2} A_\phi
\end{aligned} \quad (\text{H.13})$$

It looks like some additional cancellations may be had in the $\hat{\boldsymbol{\theta}}$ projection of this constrained vector Laplacian. I'm not inclined to try to take this reduction any further without a thorough check of all the algebra (using Mathematica to do so would make sense).

I also guessing that such a solution might be how the TE' and TM' modes were defined, but that doesn't appear to be the case according to [2]. There the wave equation is formulated in terms of the vector potentials (picking one to be zero and the other to be radial only). The

solution obtained from such a potential wave equation then directly defines the TE' and TM' modes. It would be interesting to see how the modes derived in that analysis transform with application of the vector Laplacian derived above.

I

TRANSVERSE GAUGE

Jackson [8] has an interesting presentation of the transverse gauge. I'd like to walk through the details of this, but first want to translate the preliminaries to SI units (if I had the 3rd edition I'd not have to do this translation step).

Gauge freedom The starting point is noting that $\nabla \cdot \mathbf{B} = 0$ the magnetic field can be expressed as a curl

$$\mathbf{B} = \nabla \times \mathbf{A}. \quad (\text{I.1})$$

Faraday's law now takes the form

$$\begin{aligned} 0 &= \nabla \times \mathbf{E} + \frac{\partial \mathbf{B}}{\partial t} \\ &= \nabla \times \mathbf{E} + \frac{\partial}{\partial t} (\nabla \times \mathbf{A}) \\ &= \nabla \times \left(\mathbf{E} + \frac{\partial \mathbf{A}}{\partial t} \right). \end{aligned} \quad (\text{I.2})$$

Because this curl is zero, the interior sum can be expressed as a gradient

$$\mathbf{E} + \frac{\partial \mathbf{A}}{\partial t} \equiv -\nabla \Phi. \quad (\text{I.3})$$

This can now be substituted into the remaining two Maxwell's equations.

$$\begin{aligned} \nabla \cdot \mathbf{D} &= \rho_v \\ \nabla \times \mathbf{H} &= \mathbf{J} + \frac{\partial \mathbf{D}}{\partial t} \end{aligned} \quad (\text{I.4})$$

For Gauss's law, in simple media, we have

$$\begin{aligned} \rho_v &= \epsilon \nabla \cdot \mathbf{E} \\ &= \epsilon \nabla \cdot \left(-\nabla \Phi - \frac{\partial \mathbf{A}}{\partial t} \right) \end{aligned} \quad (\text{I.5})$$

For simple media again, the Ampere-Maxwell equation is

$$\frac{1}{\mu} \nabla \times (\nabla \times \mathbf{A}) = \mathbf{J} + \epsilon \frac{\partial}{\partial t} \left(-\nabla \Phi - \frac{\partial \mathbf{A}}{\partial t} \right). \quad (\text{I.6})$$

Expanding $\nabla \times (\nabla \times \mathbf{A}) = -\nabla^2 \mathbf{A} + \nabla (\nabla \cdot \mathbf{A})$ gives

$$-\nabla^2 \mathbf{A} + \nabla (\nabla \cdot \mathbf{A}) + \epsilon\mu \frac{\partial^2 \mathbf{A}}{\partial t^2} = \mu \mathbf{J} - \epsilon\mu \nabla \frac{\partial \Phi}{\partial t}. \quad (\text{I.7})$$

Maxwell's equations are now reduced to

$$\begin{aligned} \nabla^2 \mathbf{A} - \nabla \left(\nabla \cdot \mathbf{A} + \epsilon\mu \frac{\partial \Phi}{\partial t} \right) - \epsilon\mu \frac{\partial^2 \mathbf{A}}{\partial t^2} &= -\mu \mathbf{J} \\ \nabla^2 \Phi + \frac{\partial \nabla \cdot \mathbf{A}}{\partial t} &= -\frac{\rho_v}{\epsilon}. \end{aligned} \quad (\text{I.8})$$

There are two obvious constraints that we can impose

$$\nabla \cdot \mathbf{A} - \epsilon\mu \frac{\partial \Phi}{\partial t} = 0, \quad (\text{I.9})$$

or

$$\nabla \cdot \mathbf{A} = 0. \quad (\text{I.10})$$

The first constraint is the Lorentz gauge, which I've played with previously. It happens to be really nice in a relativistic context since, in vacuum with a four-vector potential $A = (\Phi/c, \mathbf{A})$, that is a requirement that the four-divergence of the four-potential vanishes ($\partial_\mu A^\mu = 0$).

Transverse gauge Jackson identifies the latter constraint as the transverse gauge, which I'm less familiar with. With this gauge selection, we have

$$\nabla^2 \mathbf{A} - \epsilon\mu \frac{\partial^2 \mathbf{A}}{\partial t^2} = -\mu \mathbf{J} + \epsilon\mu \nabla \frac{\partial \Phi}{\partial t} \quad (\text{I.11a})$$

$$\nabla^2 \Phi = -\frac{\rho_v}{\epsilon}. \quad (\text{I.11b})$$

What's not obvious is the fact that the irrotational (zero curl) contribution due to Φ in eq. (I.11a) cancels the corresponding irrotational term from the current. Jackson uses a transverse and longitudinal decomposition of the current, related to the Helmholtz theorem to allude to this.

That decomposition follows from expanding $\nabla^2 J/R$ in two ways using the delta function $-4\pi\delta(\mathbf{x} - \mathbf{x}') = \nabla^2 1/R$ representation, as well as directly

$$\begin{aligned}
-4\pi\mathbf{J}(\mathbf{x}) &= \int \nabla^2 \frac{\mathbf{J}(\mathbf{x}')}{|\mathbf{x} - \mathbf{x}'|} d^3x' \\
&= \nabla \int \nabla \cdot \frac{\mathbf{J}(\mathbf{x}')}{|\mathbf{x} - \mathbf{x}'|} d^3x' + \nabla \cdot \int \nabla \wedge \frac{\mathbf{J}(\mathbf{x}')}{|\mathbf{x} - \mathbf{x}'|} d^3x' \\
&= -\nabla \int \mathbf{J}(\mathbf{x}') \cdot \nabla' \frac{1}{|\mathbf{x} - \mathbf{x}'|} d^3x' + \nabla \cdot \left(\nabla \wedge \int \frac{\mathbf{J}(\mathbf{x}')}{|\mathbf{x} - \mathbf{x}'|} d^3x' \right) \\
&= -\nabla \int \nabla' \cdot \frac{\mathbf{J}(\mathbf{x}')}{|\mathbf{x} - \mathbf{x}'|} d^3x' + \nabla \int \frac{\nabla' \cdot \mathbf{J}(\mathbf{x}')}{|\mathbf{x} - \mathbf{x}'|} d^3x' - \nabla \times \left(\nabla \times \int \frac{\mathbf{J}(\mathbf{x}')}{|\mathbf{x} - \mathbf{x}'|} d^3x' \right)
\end{aligned} \tag{I.12}$$

The first term can be converted to a surface integral

$$-\nabla \int \nabla' \cdot \frac{\mathbf{J}(\mathbf{x}')}{|\mathbf{x} - \mathbf{x}'|} d^3x' = -\nabla \int d\mathbf{A}' \cdot \frac{\mathbf{J}(\mathbf{x}')}{|\mathbf{x} - \mathbf{x}'|}, \tag{I.13}$$

so provided the currents are either localized or $|\mathbf{J}|/R \rightarrow 0$ on an infinite sphere, we can make the identification

$$\mathbf{J}(\mathbf{x}) = \nabla \frac{1}{4\pi} \int \frac{\nabla' \cdot \mathbf{J}(\mathbf{x}')}{|\mathbf{x} - \mathbf{x}'|} d^3x' - \nabla \times \nabla \times \frac{1}{4\pi} \int \frac{\mathbf{J}(\mathbf{x}')}{|\mathbf{x} - \mathbf{x}'|} d^3x' \equiv \mathbf{J}_l + \mathbf{J}_t, \tag{I.14}$$

where $\nabla \times \mathbf{J}_l = 0$ (irrotational, or longitudinal), whereas $\nabla \cdot \mathbf{J}_t = 0$ (solenoidal or transverse). The irrotational property is clear from inspection, and the transverse property can be verified readily

$$\begin{aligned}
\nabla \cdot (\nabla \times (\nabla \times \mathbf{X})) &= -\nabla \cdot (\nabla \cdot (\nabla \wedge \mathbf{X})) \\
&= -\nabla \cdot (\nabla^2 \mathbf{X} - \nabla (\nabla \cdot \mathbf{X})) \\
&= -\nabla \cdot (\nabla^2 \mathbf{X}) + \nabla^2 (\nabla \cdot \mathbf{X}) \\
&= 0.
\end{aligned} \tag{I.15}$$

Since

$$\Phi(\mathbf{x}, t) = \frac{1}{4\pi\epsilon} \int \frac{\rho_v(\mathbf{x}', t)}{|\mathbf{x} - \mathbf{x}'|} d^3x', \tag{I.16}$$

we have

$$\begin{aligned}
\nabla \frac{\partial \Phi}{\partial t} &= \frac{1}{4\pi\epsilon} \nabla \int \frac{\partial_t \rho_v(\mathbf{x}', t)}{|\mathbf{x} - \mathbf{x}'|} d^3x' \\
&= \frac{1}{4\pi\epsilon} \nabla \int \frac{-\nabla' \cdot \mathbf{J}}{|\mathbf{x} - \mathbf{x}'|} d^3x' \\
&= \frac{\mathbf{J}_l}{\epsilon}.
\end{aligned} \tag{I.17}$$

This means that the Ampere-Maxwell equation takes the form

$$\nabla^2 \mathbf{A} - \epsilon\mu \frac{\partial^2 \mathbf{A}}{\partial t^2} = -\mu \mathbf{J} + \mu \mathbf{J}_t = -\mu \mathbf{J}_t. \quad (\text{I.18})$$

This justifies the “transverse” in the label transverse gauge.



These Mathematica notebooks, some just trivial ones used to generate figures, others more elaborate, and perhaps some even polished, can be found in

<https://github.com/peeterjoot/mathematica/tree/master/>.

The free **Wolfram CDF player**, is capable of read-only viewing these notebooks to some extent.

- Oct 21, 2016 [ece1228-emt/ps5/ps5.nb](#)
Plots of index of refraction and relative permittivity for passive and active media.
- Nov 4, 2016 [ece1228-emt/ps6alphaPlusBetaSquareFactorization.nb](#)
A verification of the hand calculated result.
- Nov 5, 2016 [ece1228-emt/quadropoleVerificationJacksonChapter4.nb](#)
Quadropole expansion comparison attempt.
- Dec 4, 2016 [ece1228-emt/ps9/ps9p1Eigenvalues.nb](#)
ps9, p1, Slab transfer matrix eigenvalues.
- Dec 4, 2016 [ece1228-emt/ps9/ps9p2Plots.nb](#)
Problem set 9, problem 2. Plots of transmission magnitude and phase for a one dimensional photonic crystal. Plots assume: $\mu_1 = \mu_2 = 1$, normal incidence, and use the Fresnel reflection coefficient ρ_{ij} for the TE mode polarization.
- Dec 13, 2016 [ece1228-emt/BrewstersAngle.nb](#)
Total internal reflection critical angle.

Part III

INDEX

INDEX

- anisotropic, 9
- Biot-Savart, 39
- bivector, 133
- bound charge, 24
- boundary, 7
- boundary conditions, 33
 - electric field, 41
 - tangential magnetic field, 38
- breakdown voltage, 8
- capacitor, 8, 24
- conducting sheet, 15
- conductivity, 33
- conductor
 - charge dissipation, 41
- constitutive relations, 8
- constitutive relationships, 33
- continuity equation, 41
- curl, 109, 139
 - cylindrical coordinates, 133
 - spherical coordinates, 139
- curl of curl, 109
- current loop, 39
- De-Broglie relation, 11
- delta function
 - Laplacian, 109, 122
- dielectric, 24
 - boundary conditions, 41
- dipole
 - electric, 23, 27, 29
 - elemental, 26
 - potential, 30
- dipole moment density, 28
- divergence, 139
 - cylindrical coordinates, 133
 - spherical coordinates, 139
- divergence free, 13
- Divergence Theorem, 7
- doppler shift, 49
- duality theorem, 50
- electric energy density, 44
- electric field
 - direction vector, 21
 - spherical shell, 12
- electrostatic energy, 119
- electrostatics, 21
- energy
 - torque, 32
- Faraday's law, 7
- field lines
 - electric, 13
- force, 123
- Gauss's law
 - matter, 27
- Geometric Algebra, 111, 133, 139
- grade one selection, 111
- gradient, 22, 139
 - cylindrical coordinates, 18, 133
 - radial functions, 109
 - spherical coordinates, 139
- Green's function
 - Laplacian representation, 41
- Helmholtz's theorem, 11, 16

- index of refraction, 10, 49
- irrotational, 14
- Laplacian, 139
 - cylindrical coordinates, 133
 - decomposition, 109
 - Green's function, 41
 - spherical coordinates, 139
- LC circuit, 45
- line charge, 17
- Lorentz force, 123
- macroscopic, 8
- magnetic energy density, 43
- magnetic flux, 8
- magnetic moment, 31
- magnetic polarization, 31
- magnetic surface charge density, 34
- magnetization, 9, 21, 31
- magnetostatics, 123
- Mathematica, 157
- Maxwell's equations
 - point charge, 18
 - time domain, 3
- moment
 - magnetic, 31
- non-solenoidal, 13
- normal component, 111
- normal field component, 34
- number density, 25
- Ohm's law, 33
- permeability, 8
- permittivity
 - relative, 10
 - vacuum, 10
- phasor, 50
- photon
 - angular momentum, 10
 - momentum, 10
- point charge, 18, 21
- polarization, 9, 21, 24
- potential
 - electric, 22
 - electric dipole, 28, 30
- potential energy, 119
- Poynting theorem, 43
- Poynting vector, 43
 - frequency domain, 48
- projection, 111
- pseudoscalar, 139
- rejection, 111
- scalar, 133
- self energy, 119
- solenoidal, 13, 14
- spherical coordinates, 139
 - rotation matrix, 24
- Stokes' Theorem, 7
- stored electric energy, 44
- stored magnetic energy, 44
- superposition, 21
- supplied power density, 43
- surface charge density, 22
- tangential component, 111
- tangential field component, 33
- time harmonics, 45
- torque, 32, 123
- triple cross product, 111
- unit
 - ampere, 5
 - candela, 5
 - Coulomb, 5
 - Kelvin, 5
 - mole, 5
- units, 4

waveguide, [16](#)
wedge product, [139](#)

Part IV

BIBLIOGRAPHY

BIBLIOGRAPHY

- [1] Neil W Ashcroft and N David Mermin. *Solid State Physics*. Holt, Rinehart and Winston, New York, 1976.
- [2] Constantine A Balanis. *Advanced engineering electromagnetics*. Wiley New York, 1989.
- [3] C. Doran and A.N. Lasenby. *Geometric algebra for physicists*. Cambridge University Press New York, Cambridge, UK, 1st edition, 2003.
- [4] L. Dorst, D. Fontijne, and S. Mann. *Geometric Algebra for Computer Science*. Morgan Kaufmann, San Francisco, 2007.
- [5] David Jeffrey Griffiths and Reed College. *Introduction to electrodynamics*. Prentice hall Upper Saddle River, NJ, 3rd edition, 1999.
- [6] E. Hecht. *Optics*. 1998.
- [7] D. Hestenes. *New Foundations for Classical Mechanics*. Kluwer Academic Publishers, 1999.
- [8] JD Jackson. *Classical Electrodynamics*. John Wiley and Sons, 2nd edition, 1975.
- [9] A. Macdonald. *Vector and Geometric Calculus*. CreateSpace Independent Publishing Platform, 2012.
- [10] Wikipedia. Kramers-kronig relations — wikipedia, the free encyclopedia, 2016. URL https://en.wikipedia.org/w/index.php?title=Kramers%E2%80%93Kronig_relations&oldid=740053860. [Online; accessed 6-October-2016].